

**User Manual**  
**netTAP NT 50**  
**Gateway Devices**



**Hilscher Gesellschaft für Systemautomation mbH**

**[www.hilscher.com](http://www.hilscher.com)**

DOC091202UM09EN | Revision 9 | English | 2013-02 | Released | Public

# Table of Contents

1	INTRODUCTION .....	5
1.1	About the User Manual .....	5
1.1.1	Obligation to read and understand the Manual .....	5
1.1.2	List of Revisions .....	6
1.1.3	Conventions in this Manual .....	7
1.2	Reference to Hardware, Software and Firmware .....	8
1.3	Contents of the Product DVD .....	9
1.3.1	Directory Structure of the DVD .....	9
1.3.2	Device Description Files .....	10
1.3.3	Documentation for netTAP NT 50 .....	11
1.4	Legal Notes .....	13
1.4.1	Copyright .....	13
1.4.2	Important Notes .....	13
1.4.3	Exclusion of Liability .....	14
1.4.4	Warranty .....	14
1.4.5	Export Regulations .....	15
1.4.6	Registered Trademarks .....	15
2	SAFETY .....	16
2.1	General Note .....	16
2.2	Intended Use .....	16
2.3	Personnel Qualification .....	16
2.4	References Safety .....	16
2.5	Safety Instructions to avoid Personal Injury .....	17
2.5.1	Danger of unsafe System Operation .....	17
2.6	Safety Instructions to avoid Property Damage .....	17
2.6.1	Device Destruction by exceeding allowed Supply Voltage .....	17
2.6.2	Danger of unsafe System Operation .....	17
2.7	Labeling of Safety Messages .....	18
3	DESCRIPTION AND REQUIREMENTS .....	19
3.1	Device Description .....	19
3.2	Device Types and Protocol Conversions .....	20
3.2.1	Device Names .....	20
3.2.2	Protocol Conversions .....	21
3.3	System Requirements .....	22
3.4	Configuration Requirements .....	22
4	DEVICE DRAWINGS AND CONNECTIONS .....	23
4.1	Device and Dimensioned Drawings .....	23
4.2	Positions of LEDs and Control Elements .....	24
4.2.1	Range of Values for the Address Switches .....	24
4.3	Connections .....	25
4.3.1	X1 Top Connection .....	25
4.3.2	X2 Front Connection .....	25
4.3.3	X3 Bottom Connection .....	28

4.4	Schematic Diagram - Galvanic Isolation .....	32
4.4.1	Galvanic Isolation of NT 50-xx-EN Devices .....	32
4.4.2	Galvanic Isolation of NT 50-xx-RS .....	33
4.4.3	Galvanic Isolation of NT 50-RS-EN .....	34
5	NT 50 MOUNTING AND DISMOUNTING .....	35
5.1	DIN Top Hat Rail Mounting of the NT 50 .....	35
5.2	Removing the NT 50 from the DIN Top Hat Rail .....	35
6	COMMISSIONING .....	36
6.1	Load Firmware and Configuration .....	36
6.1.1	Download Configuration Files from the PC .....	36
6.1.2	Potential Differences for Device Types NT 50-xx-RS .....	37
6.2	Start-up Behavior .....	37
7	TROUBLESHOOTING .....	38
7.1	Failure in 10 MBit/s Half Duplex Mode and Workaround .....	39
8	LEDS .....	40
8.1	System LEDs .....	40
8.2	LEDS Real Time Ethernet Protocols .....	41
8.2.1	LEDS EtherNet/IP Scanner (Master) .....	41
8.2.2	LEDS EtherNet/IP Adapter (Slave) .....	42
8.2.3	LEDS Open Modbus/TCP .....	43
8.2.4	LEDS PROFINET IO Controller .....	44
8.2.5	LEDS PROFINET IO-RT-Device .....	45
8.3	LEDS Fieldbus Protocols .....	46
8.3.1	LED PROFIBUS-DP Master .....	46
8.3.2	LED PROFIBUS-DP Slave .....	46
8.3.3	LED CANopen Master .....	47
8.3.4	LED CANopen Slave .....	48
8.3.5	LED DeviceNet Master .....	49
8.3.6	LED DeviceNet Slave .....	49
8.3.7	LED CC-Link Slave .....	50
8.4	LEDS Serial Protocols .....	51
8.4.1	LED Modbus RTU .....	51
8.4.2	LED ASCII .....	51
9	TECHNICAL DATA .....	52
9.1	Technical Data netTAP 50 Gateway .....	52
9.2	Technical Data of Real-Time Ethernet Communication Protocols .....	54
9.2.1	EtherNet/IP Scanner (Master) Link .....	54
9.2.2	EtherNet/IP Adapter (Slave) .....	55
9.2.3	Open Modbus/TCP .....	56
9.2.4	PROFINET IO-RT-Controller Link .....	57
9.2.5	PROFINET IO-RT-Device .....	58
9.3	Technical Data Fieldbus Protocols .....	59
9.3.1	CANopen Master Link .....	59
9.3.2	CANopen Slave .....	60
9.3.3	CC-Link Slave .....	61

---

9.3.4	DeviceNet Master Link .....	62
9.3.5	DeviceNet Slave .....	63
9.3.6	PROFIBUS-DP Master Link .....	64
9.3.7	PROFIBUS DP Slave .....	65
9.4	Technical Data serial Protocols .....	66
9.4.1	ASCII .....	66
9.4.2	Modbus RTU Master/Slave .....	67
10	WIRING INSTRUCTIONS .....	68
10.1	Assembly of D-Sub Connectors.....	69
10.2	Ethernet .....	70
10.3	PROFIBUS .....	71
10.4	CANopen .....	73
10.5	DeviceNet .....	74
10.6	CC-Link.....	76
10.7	RS-232.....	78
10.8	RS-422.....	79
10.9	RS-485.....	81
11	DECOMMISSIONING/DISPOSAL.....	83
11.1	Put the Device out of Operation.....	83
11.2	Disposal of Waste Electronic Equipment.....	83
12	APPENDIX .....	84
12.1	List of Figures .....	84
12.2	List of Tables .....	84
12.3	Contacts.....	86

# 1 Introduction

## 1.1 About the User Manual

This user manual describes the hardware, installation, commissioning, and operation of the netTAP NT 50 series of gateways.

### 1.1.1 Obligation to read and understand the Manual



---

**Important!**

- To avoid personal injury and to avoid property damage to your system or to your device, you must read and understand all instructions in the manual and all accompanying texts to your device, before installing and operating your device.
  - First read the **Safety Instructions** in the safety chapter.
  - Obey to all **Safety Messages** in the manual.
  - Keep the product DVD providing the product manuals.
-

## 1.1.2 List of Revisions

Index	Date	Chapter	Revisions
5	2011-06-09	1.2 1.3.2 1.3.3 3.2.2 3.4 8.2.4 9.2.4 9.2.5 9.3.4	Section <i>Reference to Hardware, Software and Firmware</i> updated. Section <i>Device Description Files</i> updated. Section <i>Documentation for netTAP NT 50</i> expanded. Section <i>Protocol Conversions</i> : File names for Master Link corrected. Section <i>Configuration Requirements</i> updated: Windows® Vista and Windows® 7 added. Section <i>LEDs PROFINET IO Controller</i> added. Section <i>PROFINET IO-RT-Controller Link</i> updated. Section <i>PROFINET IO-RT-Device</i> updated. Section <i>DeviceNet Master Link</i> : Quick Connect added.
6	2012-02-04	8.2.4 8.3.3 9.2.3	Section <i>LEDs PROFINET IO Controller</i> : updated. Section <i>LED CANopen Master</i> : Correction. Section <i>Open Modbus/TCP</i> : Correction to 'Max. 256 Registers'.
7	2012-07-13	1.2 3.2.2 4.2	Section <i>Reference to Hardware, Software and Firmware</i> updated. Section <i>Protocol Conversions</i> firmware version updated. Section <i>Positions of LEDs and Control Elements</i> address switch added.
8	2012-11-09	3.4 7.1 8.3.4 8.3.7 9.2.1 9.3.2 9.3.3 9.3.5 9.3.7	<b>Firmware Version 1.1.x.x</b> Section <i>Configuration Requirements</i> updated. Section <i>Failure in 10 MBit/s Half Duplex Mode and Workaround</i> : Serial numbers added. Section <i>LED CANopen Slave</i> : State for baudrate detection added. Section <i>LED CC-Link Slave</i> added. Section <i>EtherNet/IP Scanner (Master) Link</i> : Address Conflict Detection is supported. Section <i>CANopen Slave</i> : - Event timer added, - Address switch added, - Auto baudrate detection is supported. Section <i>CC-Link Slave</i> : Address switch added. Section <i>DeviceNet Slave</i> : Address switch added. Section <i>PROFIBUS DP Slave</i> : - Maximum number of modules: Max. 4 input modules and max. 4 output modules, max. 24 modules when using manual setting, - Address switch added.
9	2013-02-04	1.3.3	Section <i>Documentation for netTAP NT 50</i> updated.

Table 1: List of Revisions

### 1.1.3 Conventions in this Manual

Operation instructions, a result of an operation step or notes are marked as follows:

**Operation Instructions:**

➤ <instruction>

or

1. <instruction>

2. <instruction>

**Results:**

↻ <result>

**Notes:**



---

**Important:** <important note>

---



---

**Note:** <note>

---



---

<note, where to find further information>

---

**Numbering:**

① ... ② reference to the figure used in that section. If the numbers reference to a section outside the current section then a cross reference to that section and figure is indicated.

## 1.2 Reference to Hardware, Software and Firmware

### Hardware

Device Type	Revision	Port X2	Port X3
NT 50-CO-EN	2	CANopen	Ethernet
NT 50-CO-RS	2	CANopen	Ethernet + Serial
NT 50-CC-EN	2	CC-Link	Ethernet
NT 50-CC-RS	2	CC-Link	Ethernet + Serial
NT 50-DN-EN	2	DeviceNet	Ethernet
NT 50-DN-RS	2	DeviceNet	Ethernet + Serial
NT 50-DP-EN	2	PROFIBUS-DP	Ethernet
NT 50-DP-RS	2	PROFIBUS-DP	Ethernet + Serial
NT 50-RS-EN	2	Serial	Ethernet

Table 2: Reference to Hardware

### Software

Software	Version
SYCON.net	1.351.x.x or higher

Table 3: Reference to Software

### Firmware

Firmware for the protocol conversion see section *Protocol Conversions* on page 21.



## 1.3 Contents of the Product DVD

The product DVD gateway solutions for the netTAP NT 50 contains:

- Setup program for the configuration and diagnostic program SYCON.net and for Ethernet Device Setup program.
- Documentation
- Firmware
- Device Description Files (GSD, GSDML, EDS, ...)
- Video-Audio Tutorials
- Presentations
- Tools

### 1.3.1 Directory Structure of the DVD

All manuals on this DVD are delivered in the Adobe Acrobat® Reader format (PDF).

Directory Name	Description
Documentation	Documentation in the Acrobat® Reader Format (PDF)
Driver	not relevant for NT 50
EDS	Device Description File
Examples	Example files (not relevant for NT 50)
Firmware	Loadable Firmware
fscommand	Files for installation
Presentations	Product Presentationen in PowerPoint pps format
Software	Configuration and diagnostic program SYCON.net
Tools	not relevant for NT 50
Video-Audio Tutorials	Video Tutorial in AVI Format
Workshop	not relevant for NT 50

Table 4: Directory Structure of the gateway solution DVD

### 1.3.2 Device Description Files

The directory EDS on the DVD provides device description files for the netTAP NT 50 device.

netTAP NT 50 as	File name
CC-Link Slave	NT50_CC_CCS_1.csp (for one Remote Device Station), NT50_CC_CCS_2.csp (for two Remote Device Stations), NT50_CC_CCS_3.csp (for three Remote Device Stations), NT50_CC_CCS_4.csp (for four Remote Device Stations), NT50_CC_CCS_IO.csp (for one Remote IO Station)
CANopen Slave	NT50_CO_COS.EDS
DeviceNet Slave	NT50_DN_DNS.EDS
EtherNet/IP Adapter	HILSCHER NT 50-EN EIS V1.1.EDS
PROFIBUS-DP Slave	HIL_0C99.GSD
PROFINET IO Device	GSDML-V2.2-HILSCHER-NT 50-EN PNS-20120806-143000.xml

*Table 5: Device Description Files for netTAP NT 50 on the DVD*

The device description files are for the configuration of the used master.

### 1.3.3 Documentation for netTAP NT 50

The following documentation overview gives information, for which items you can find further information in which manual.



**Note:** Further information: All manuals listed in the overview below can be found in the Documentation directory on the DVD delivered, in the Adobe Acrobat® Reader format (PDF).

#### Basic documentation for netTAP NT 50

You always need the following documents:

Manual	Contents	Document Name
User Manual	netTAP NT 50 Installation, Operation and Hardware	netTAP NT 50 - Gateway Devices UM xx EN.pdf (this manual)
User Manual	Software Installation Gateway Solutions	Software Installation - Gateway Solutions UM xx EN.pdf
User Manual	Ethernet Device Configuration Assignment of an IP Address for the netTAP NT 50	Ethernet Device Configuration OI xx EN.pdf
Operating Instruction Manual	Configuration of Gateway and Proxy Devices netTAP, netBRICK and netLINK Step by step description of the configuration of the netTAP NT 50. Configuration of the netTAP NT 50 as EtherNet/IP Adapter, Open Modbus/TCP, PROFINET IO Device, CANopen Slave, CC-Link Slave, DeviceNet Slave, PROFIBUS-DP Slave, Modbus RTU Master/Slave, ASCII.	Configuration of Gateway and Proxy Devices OI xx EN.pdf

Table 6: Basic Documentation for netTAP NT 50

#### netTAP NT 50 with EtherNet/IP Scanner/Master Link

You need the following additional documents, if you use the protocol EtherNet/IP Scanner/Master on the gateway device:

Manual	Contents	Document name
Operating Instruction Manual	DTM for EtherNet/IP Scanner devices	EtherNetIP Scanner DTM OI xx EN.pdf
Operating Instruction Manual	Generic DTM from EDS File EtherNet/IP Adapter Devices	EtherNetIP Generic Adapter DTM EDS OI xx EN.pdf
Operating Instruction Manual	Generic DTM for EtherNet/IP Adapter devices	EtherNetIP Generic Adapter DTM OI xx EN.pdf

Table 7: Additional Documentation for netTAP NT 50 with EtherNet/IP Scanner/Master Link

**netTAP NT 50 with PROFINET IO Controller Link**

You need the following additional documents, if you use the protocol PROFINET IO Controller on the gateway device:

Manual	Contents	Document name
Operating Instruction Manual	DTM for PROFINET IO Controller devices	PROFINET IO Controller DTM OI xx EN.pdf
Operating Instruction Manual	Generic DTM for PROFINET IO Device devices	PROFINET IO Generic Device DTM IO xx EN.pdf

*Table 8: Additional Documentation for netTAP NT 50 with PROFINET IO Controller Link*

**netTAP NT 50 with CANopen Master Link**

You need the following additional documents, if you use the protocol CANopen Master on the gateway device:

Manual	Contents	Document name
Operating Instruction Manual	DTM for CANopen Master devices	CANopen Master DTM OI xx EN.pdf
Operating Instruction Manual	Generic DTM for CANopen Slave devices	CANopen Generic Slave DTM OI xx EN.pdf

*Table 9: Additional Documentation for netTAP NT 50 with CANopen Master Link*

**netTAP NT 50 with DeviceNet Master Link**

You need the following additional documents, if you use the protocol DeviceNet Master on the gateway device:

Manual	Contents	Document name
Operating Instruction Manual	DTM for DeviceNet Master devices	DeviceNet Master DTM OI xx EN.pdf
Operating Instruction Manual	Generic DTM for DeviceNet Slave devices	DeviceNet Generic Slave DTM OI xx EN.pdf

*Table 10: Additional Documentation for netTAP NT 50 with DeviceNet Master Link*

**netTAP NT 50 with PROFIBUS DP Master Link**

You need the following additional documents, if you use the protocol PROFIBUS DP Master on the gateway device:

Manual	Contents	Document name
Operating Instruction Manual	DTM for PROFIBUS DP Master devices	PROFIBUS DP Master DTM OI xx EN.pdf
Operating Instruction Manual	Generic DTM for PROFIBUS DP Slave devices	PROFIBUS DP Generic Slave DTM OI xx EN.pdf

*Table 11: Additional Documentation for netTAP NT 50 with PROFIBUS DP Master Link*

**netTAP NT 50 with ASCII**

You need the following additional documents, if you use the protocol ASCII on the gateway device:

Manual	Contents	Document name
User Manual	ASCII Handshake Mechanism	ASCII – Handshake Mechanism UM xx EN.pdf

*Table 12: Additional Documentation for netTAP NT 50 with ASCII*

## 1.4 Legal Notes

### 1.4.1 Copyright

© Hilscher, 2010-2013, Hilscher Gesellschaft für Systemautomation mbH

All rights reserved.

The images, photographs and texts in the accompanying material (user manual, accompanying texts, documentation, etc.) are protected by German and international copyright law as well as international trade and protection provisions. You are not authorized to duplicate these in whole or in part using technical or mechanical methods (printing, photocopying or other methods), to manipulate or transfer using electronic systems without prior written consent. You are not permitted to make changes to copyright notices, markings, trademarks or ownership declarations. The included diagrams do not take the patent situation into account. The company names and product descriptions included in this document may be trademarks or brands of the respective owners and may be trademarked or patented. Any form of further use requires the explicit consent of the respective rights owner.

### 1.4.2 Important Notes

The user manual, accompanying texts and the documentation were created for the use of the products by qualified experts, however, errors cannot be ruled out. For this reason, no guarantee can be made and neither juristic responsibility for erroneous information nor any liability can be assumed. Descriptions, accompanying texts and documentation included in the user manual do not present a guarantee nor any information about proper use as stipulated in the contract or a warranted feature. It cannot be ruled out that the user manual, the accompanying texts and the documentation do not correspond exactly to the described features, standards or other data of the delivered product. No warranty or guarantee regarding the correctness or accuracy of the information is assumed.

We reserve the right to change our products and their specification as well as related user manuals, accompanying texts and documentation at all times and without advance notice, without obligation to report the change. Changes will be included in future manuals and do not constitute any obligations. There is no entitlement to revisions of delivered documents. The manual delivered with the product applies.

Hilscher Gesellschaft für Systemautomation mbH is not liable under any circumstances for direct, indirect, incidental or follow-on damage or loss of earnings resulting from the use of the information contained in this publication.

### 1.4.3 Exclusion of Liability

The software was produced and tested with utmost care by Hilscher Gesellschaft für Systemautomation mbH and is made available as is. No warranty can be assumed for the performance and flawlessness of the software for all usage conditions and cases and for the results produced when utilized by the user. Liability for any damages that may result from the use of the hardware or software or related documents, is limited to cases of intent or grossly negligent violation of significant contractual obligations. Indemnity claims for the violation of significant contractual obligations are limited to damages that are foreseeable and typical for this type of contract.

It is strictly prohibited to use the software in the following areas:

- for military purposes or in weapon systems;
- for the design, construction, maintenance or operation of nuclear facilities;
- in air traffic control systems, air traffic or air traffic communication systems;
- in life support systems;
- in systems in which failures in the software could lead to personal injury or injuries leading to death.

We inform you that the software was not developed for use in dangerous environments requiring fail-proof control mechanisms. Use of the software in such an environment occurs at your own risk. No liability is assumed for damages or losses due to unauthorized use.

### 1.4.4 Warranty

Although the hardware and software was developed with utmost care and tested intensively, Hilscher Gesellschaft für Systemautomation mbH does not guarantee its suitability for any purpose not confirmed in writing. It cannot be guaranteed that the hardware and software will meet your requirements, that the use of the software operates without interruption and that the software is free of errors. No guarantee is made regarding infringements, violations of patents, rights of ownership or the freedom from interference by third parties. No additional guarantees or assurances are made regarding marketability, freedom of defect of title, integration or usability for certain purposes unless they are required in accordance with the law and cannot be limited. Warranty claims are limited to the right to claim rectification.

## 1.4.5 Export Regulations

The delivered product (including the technical data) is subject to export or import laws as well as the associated regulations of different countries, in particular those of Germany and the USA. The software may not be exported to countries where this is prohibited by the United States Export Administration Act and its additional provisions. You are obligated to comply with the regulations at your personal responsibility. We wish to inform you that you may require permission from state authorities to export, re-export or import the product.

## 1.4.6 Registered Trademarks

Windows® XP, Windows® Vista and Windows® 7 are registered trademarks of Microsoft Corporation.

Adobe-Acrobat® is a registered trademark of the Adobe Systems Incorporated.

CANopen® is a registered trademark of CAN in AUTOMATION - International Users and Manufacturers Group e.V (CiA), Nürnberg.

CC-Link® is a registered trademark of Mitsubishi Electric Corporation, Tokyo, Japan.

DeviceNet® and EtherNet/IP® are trademarks of ODVA (Open DeviceNet Vendor Association, Inc).

Modbus® is a registered trademark of Schneider Electric.

PROFIBUS and PROFINET are registered trademarks of PROFIBUS International, Karlsruhe.

All other mentioned trademarks are property of their respective legal owners.

## 2 Safety

### 2.1 General Note

The user manual, the accompanying texts and the documentation are written for the use of the products by educated personnel. When using the products, all safety instructions and all valid legal regulations have to be obeyed. Technical knowledge is presumed. The user has to assure that all legal regulations are obeyed.

### 2.2 Intended Use

Devices described in this manual:

- NT 50-CC-EN,
- NT 50-CC-RS,
- NT 50-CO-EN,
- NT 50-CO-RS,
- NT 50-DN-EN,
- NT 50-DN-RS,
- NT 50-DP-EN,
- NT 50-DP-RS,
- NT 50-RS-EN,

are devices for communication and connect two communication networks. The NT 50 devices work as a gateway between these two networks.

The NT 50 devices are in a compact housing and suitable for DIN rail mounting according to DIN EN 60715.

The devices should be operated only in an environment appropriate to the technical data.

### 2.3 Personnel Qualification

The netTAP NT 50 Gateway must only be installed, configured and removed by qualified personnel. Job-specific technical skills for people professionally working with electricity must be present concerning the following topics:

- Safety and health at work
- Mounting and attaching of electrical equipment
- Measurement and Analysis of electrical functions and systems
- Evaluation of the safety of electrical systems and equipment
- Installing and Configuring IT

### 2.4 References Safety

- [1] ANSI Z535.6-2006 American National Standard for Product Safety Information in Product Manuals, Instructions, and Other Collateral Materials
- [2] IEC 60950-1, Information technology equipment - Safety - Part 1: General requirements, (IEC 60950-1:2005, modified); German Edition EN 60950-1:2006
- [3] EN 61340-5-1 and EN 61340-5-2 as well as IEC 61340-5-1 and IEC 61340-5-2



## 2.5 Safety Instructions to avoid Personal Injury

To ensure your own personal safety and to avoid personal injury, you necessarily must read, understand and follow the following safety instructions and all safety messages in this manual about danger causing personal injury, before you install and operate your netTAP NT 50 device.

### 2.5.1 Danger of unsafe System Operation

To prevent harm of persons, do not remove this device under runtime conditions before you can not guarantee further a safe and secure operation of the plant.

## 2.6 Safety Instructions to avoid Property Damage

To avoid property damage respectively device destruction of the netTAP NT 50 device, you necessarily must read, understand and follow the following safety instructions and all safety messages in this manual about danger causing property damage, before you install and operate your netTAP NT 50 device.

### 2.6.1 Device Destruction by exceeding allowed Supply Voltage

Adhere for all netTAP NT 50 device described in this manual the instruction hereafter:

The netTAP NT 50 may only be operated with the specified supply voltage. Make sure that the limits of the allowed range for the supply voltage are not exceeded. A supply voltage above the upper limit can cause severe damage to the netTAP NT 50! A supply voltage below the lower limit can cause malfunction in the netTAP NT 50. The allowed range for the supply voltage is defined by the tolerances specified in this manual.



---

The data on the mandatory supply voltage for the netTAP NT 50 device you find in the section *System Requirements* on page 22. There the required and permitted supply voltage for the netTAP NT 50 device is provided inclusively the permitted tolerance range.

---

### 2.6.2 Danger of unsafe System Operation

To prevent property damage, do not remove this device under runtime conditions before you can not guarantee further a safe and secure operation of the plant.

## 2.7 Labeling of Safety Messages

- The **Section Safety Messages** at the beginning of a chapter are pin-pointed particularly. They are highlighted with a specific safety symbol and a signal word according to the degree of endangerment. Inside the safety message the danger is exactly named.
- The **Integrated Safety Messages** within a instruction description are highlighted with a signal word according to the degree of endangerment and possibly by an principle symbol. Inside the safety message the danger is exactly named.



Safety Symbol	Safety Symbol (USA)	Sort of Warning or Principle
		Warning of Personal Injury and Property Damage Message <b>USA:</b> Warning of Personal Injury As in the scope of the ANSI Z535 Standard (for USA) instructions to a property damage message may not contain a warning triangle, this property damage messages are listed separatly for the USA.
		Warning of Damages by Electrostatic Discharge

Table 13: Safety Symbols and Sort of Warning or Principle

Signal Word	Meaning	Meaning (USA)
<b>NOTICE</b>	Indicates a Property Damage Message.	Indicates a Property Damage Message.
<b>Note</b>	Indicates an important note in the manual.	Indicates an Important Note in the Manual.

Table 14: Signal Words

In this document all Safety Instructions and Safety Messages are designed according both to the international used safety conventions as well as to the ANSI Z535 standard, refer to reference safety [S1].

## 3 Description and Requirements

### 3.1 Device Description

The netTAP NT 50 devices described in this manual are communication devices that are connecting two networks to each other. The NT 50 devices are operating as gateway between both networks.

The netTAP NT 50 is a device with two interface ports. Its principle functionality is illustrated in the figure below. The function of the device is determined by the loaded firmware and the loaded configuration.

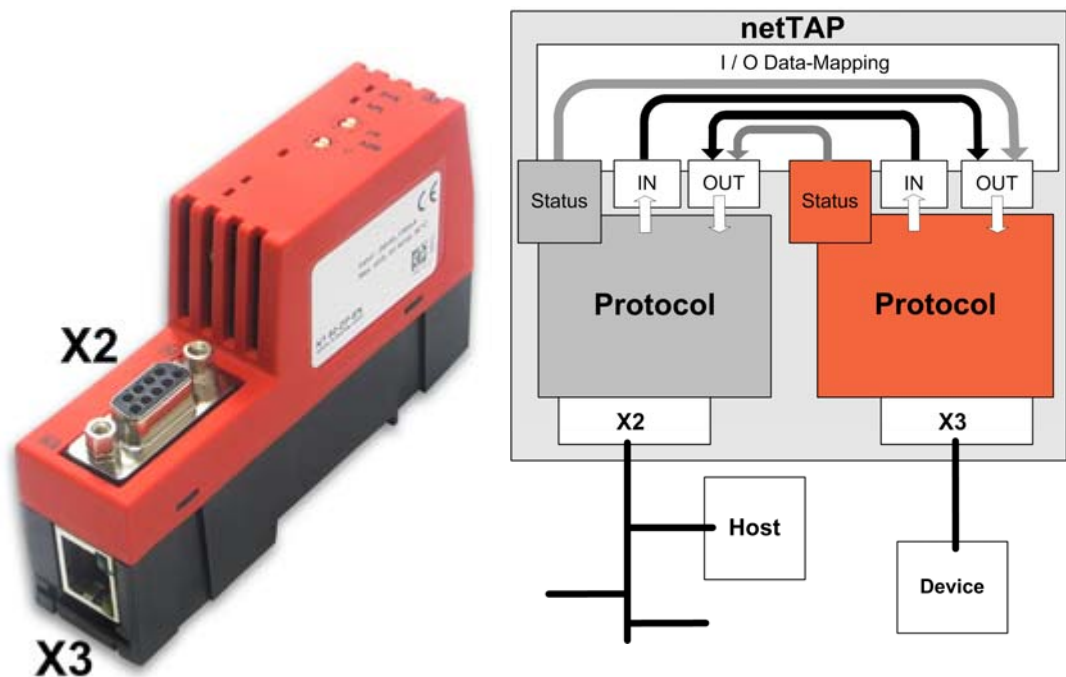

Figure 1: Function NT 50

The interface X2 is a fieldbus interface, the interface X3 may be an Ethernet or a serial interface (RS).

The fieldbus interface X2 is located at the front of the device. The Ethernet respectively the serial interface is located at the bottom of the device (X3).

Basically it is possible to connect either to port X2 or X3 to a host or to field devices.

The netTAP NT 50 device is configured by a PC and the software SYCON.net. Online diagnosis is possible via the same interface. The Ethernet interface of the netTAP NT 50 device is used for configuration and for diagnostic. This PC is a part of the Ethernet network.



Information about the configuration of the device with SYCON.net software is in the manual „netGateway\_DTM\_en.pdf“ on the product DVD in the directory „Documentation“.

The gateway functionality is determined by the loadable firmware.

The firmware buffers the cyclic send and receive data of the protocol at port X2 and the protocol of port X3 internally. The configuration tool enables the flexible mapping of the receive data of protocol X2 to send data of the protocol X3 and vice versa.

Status information of the protocol at port X2 can be mapped into the send data of the protocol at port X3 and vice versa.

The firmware of netTAP NT 50 as gateway does not support acyclic communications or services of the supported protocols.

If the device is operated in a bus system as a master, then exactly one slave can be connected. Thus, for example for protocols with master functionality the designation „PROFIBUS-DP Master Link“ means, that one PROFIBUS-DP Slave can be connected.

## 3.2 Device Types and Protocol Conversions

### 3.2.1 Device Names

The descriptive device name of netTAP devices consists of the following parts

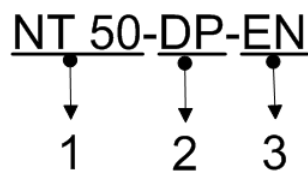

1. Device Type netTAP 50
2. Network on port X2 (upper port on the device), in the example DP for PROFIBUS-DP.
3. Network on port X3 (port at the bottom of the device) , in the example RE for Real-time Ethernet

The following communication systems are currently supported at the primary network X2:

Code 2	Supported Communication System
CC	CC-Link
CO	CANopen
DN	DeviceNet
DP	PROFIBUS DP
RS	Serial (Modbus RTU or ASCII)

Table 15: Network on port X2 (Primary Network)

The following communication systems are currently supported at the secondary network X3:

Code 3	Supported Communication System
EN	Ethernet (1* RJ45)
RS	Serial (Modbus RTU or ASCII) (RJ45)

Table 16: Network on port X3 (Secondary Network)

### 3.2.2 Protocol Conversions

The following table lists the protocol conversion and the necessary netTAP NT 50 device type.

Device Name	Protocol at X2	Protocol at X3	Firmware File	Firmware Version
NT 50-CC-EN	CC-Link Slave	EtherNet/IP Adapter/Slave EtherNet/IP Scanner/Master (1) PROFINET IO Device PROFINET IO Controller (1) Open Modbus/TCP	N5CCSEIS.NXF N5CCSEIM.NXF N5CCSPNS.NXF N5CCSPNM.NXF N5CCSOMB.NXF	1.1.x.x
NT 50-CC-RS	CC-Link Slave	ASCII Modbus RTU Master / Slave	N5CCSASC.NXF N5CCSMBR.NXF	
NT 50-CO-EN	CANopen Master (for one slave)	EtherNet/IP Adapter/Slave PROFINET IO Device Open Modbus/TCP	N5COMEIS.NXF N5COMPNS.NXF N5COMOMB.NXF	
	CANopen Slave	EtherNet/IP Adapter/Slave EtherNet/IP Scanner/Master (1) PROFINET IO Device PROFINET IO Controller (1) Open Modbus/TCP	N5COSEIS.NXF N5COSEIM.NXF N5COSPNS.NXF N5COSPNM.NXF N5COSOMB.NXF	
NT 50-CO-RS	CANopen Master (for one slave)	ASCII Modbus RTU Master / Slave	N5COMASC.NXF N5COMMBR.NXF	
	CANopen Slave	ASCII Modbus RTU Master / Slave	N5COSASC.NXF N5COSMBR.NXF	
NT 50-DN-EN	DeviceNet Master (for one slave)	EtherNet/IP Adapter/Slave PROFINET IO Device Open Modbus/TCP	N5DNMEIS.NXF N5DNMPNS.NXF N5DNMOMB.NXF	
	DeviceNet Slave	EtherNet/IP Adapter/Slave EtherNet/IP Scanner/Master (1) PROFINET IO Device PROFINET IO Controller (1) Open Modbus/TCP	N5DNSEIS.NXF N5DNSEIM.NXF N5DNSPNS.NXF N5DNSPNM.NXF N5DNSOMB.NXF	
NT 50-DN-RS	DeviceNet Master (for one slave)	ASCII Modbus RTU Master / Slave	N5DNMASC.NXF N5DNMMBR.NXF	
	DeviceNet Slave	ASCII Modbus RTU Master / Slave	N5DNSASC.NXF N5DNSMBR.NXF	
NT 50-DP-EN	PROFIBUS-DP Master (for one slave)	EtherNet/IP Adapter/Slave PROFINET IO Device Open Modbus/TCP	N5DPMEIS.NXF N5DPMPNS.NXF N5DPMOMB.NXF	
	PROFIBUS-DP Slave	EtherNet/IP Adapter/Slave EtherNet/IP Scanner/Master (1) PROFINET IO Device PROFINET IO Controller (1) Open Modbus/TCP	N5DPSEIS.NXF N5DPSEIM.NXF N5DPSPNS.NXF N5DPSPNM.NXF N5DPSOMB.NXF	
NT 50-DP-RS	PROFIBUS-DP Master (for one slave)	ASCII Modbus RTU Master / Slave	N5DPMASC.NXF N5DPMMBR.NXF	
	PROFIBUS-DP Slave	ASCII Modbus RTU Master / Slave	N5DPSASC.NXF N5DPSMBR.NXF	
NT 50-RS-EN	ASCII	EtherNet/IP Adapter/Slave Ethernet/IP Scanner/Master (1) PROFINET IO Device PROFINET IO Controller (1) Open Modbus/TCP	N5ASCEIS.NXF N5ASCEIM.NXF N5ASCPNS.NXF N5ASCPNM.NXF N5ASCOMB.NXF	
	Modbus RTU Master/Slave	EtherNet/IP Adapter/Slave EtherNet/IP Scanner/Master (1) PROFINET IO Device PROFINET IO Controller (1) Open Modbus/TCP	N5MBREIS.NXF N5MBREIM.NXF N5MBRPNS.NXF N5MBRPNM.NXF N5MBROMB.NXF	

Table 17: List of Protocol Conversion and NT 50 Device Type

### 3.3 System Requirements

The netTAP NT 50 device must be mounted on a DIN-rail according to DIN EN 60715.

A suitable power supply is required. The voltage to be applied must be in the allowed range  $24\text{ V} \pm 6\text{ V DC}$ . The power supply must be able to deliver at least a current of 100 mA at 24 V.

Power supply is possible via pins 1 (GND) and 2 (24V) of the netTAP NT 50 power supply connector located on the upper side of the device.

---

**NOTICE****Device Destruction!**

- The voltage must not exceed 30 V significantly, otherwise the device may be destroyed or damaged.

---

In order to avoid damage caused by overheating or freezing, it is necessary that the temperature of the device does not exceed the limits of the allowed temperature range.

The following preconditions must additionally be met in order to operate the Gateway device successfully:

1. The Gateway device must have been provided with the correctly suiting firmware.
2. The Gateway device must have been configured correctly using the SYCON.net configuration software.

### 3.4 Configuration Requirements

The configuration software SYCON.net must be installed on a PC. The requirements for the PC are:

- PC with 1 GHz processor or higher
- Windows® XP SP3, Windows® Vista (32 bit) SP2, Windows® 7 (32 bit) or Windows® 7 (64 bit)
- Administrator rights
- Internet Explorer 5.5 or higher
- Free disk space: min. 400 MByte
- DVD ROM drive
- RAM: min. 512 MByte, recommended 1024 MByte
- Graphic resolution: min. 1024 x 768 pixel
- Keyboard and Mouse
- USB



**Note:** If the project file is saved and opened again or it is used on another PC, the system requirements need to match. Particularly the DTMs need to be installed on the used PC.

---

# 4 Device Drawings and Connections

## 4.1 Device and Dimensioned Drawings

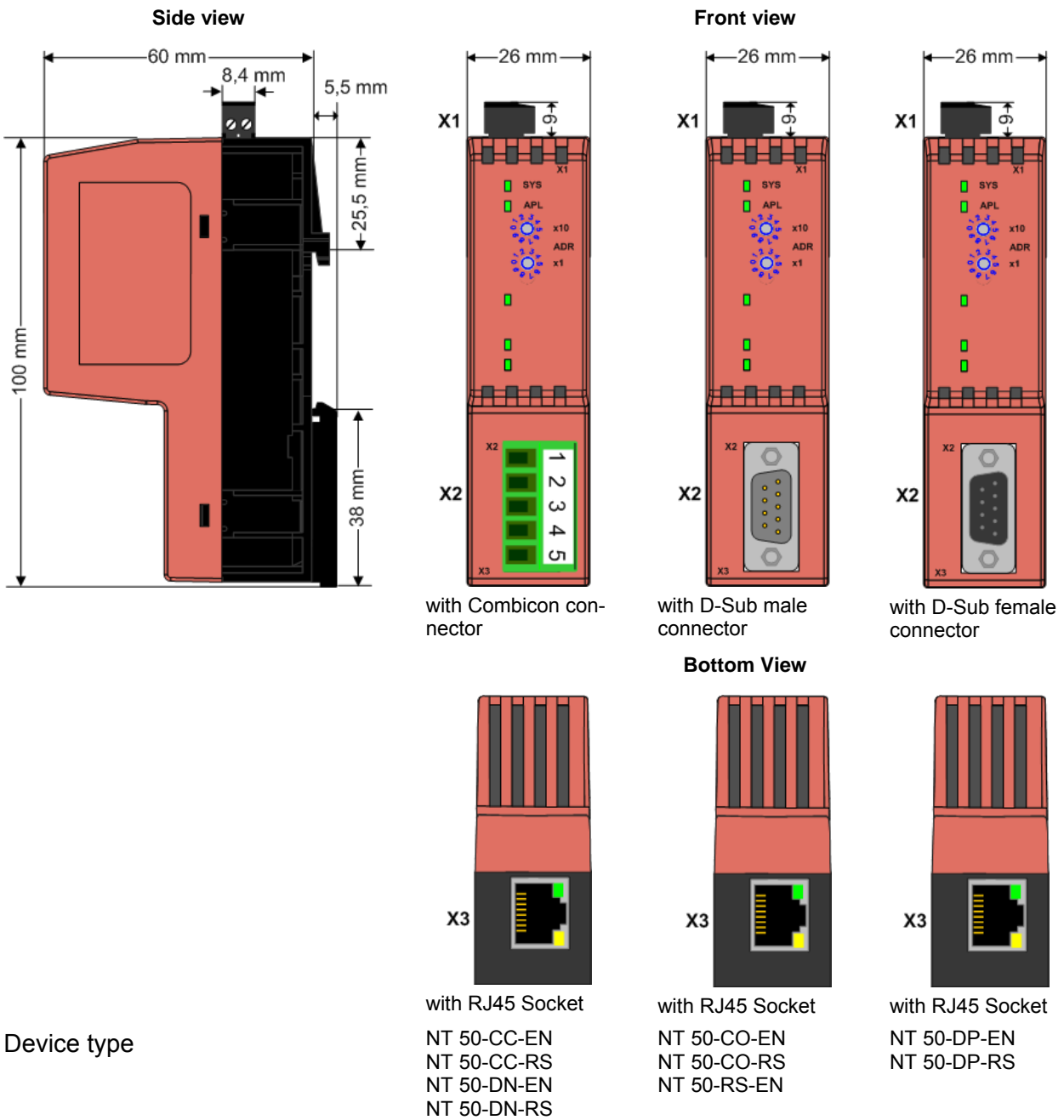
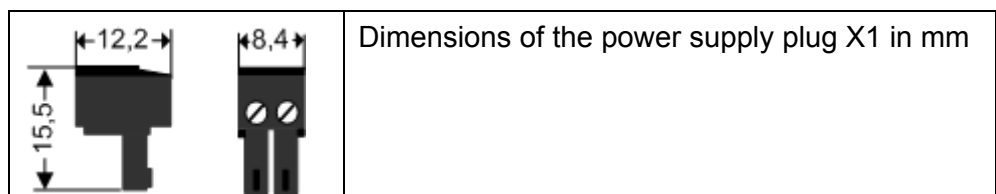

Figure 2: Device Drawings

In the drawing above:

X1 Connector for Power Supply

X2 and X3 Communication interfaces



## 4.2 Positions of LEDs and Control Elements

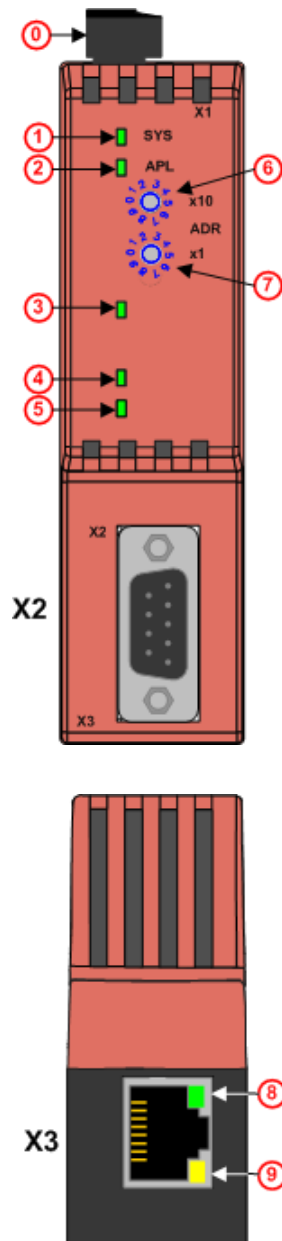

Meaning of the elements

- ① Connector X1 for power supply
- ① SYS-LED
- ② APL-LED
- ③ COM-LED
- ④ LED, depends on protocol at X2
- ⑤ LED, depends on protocol at X2
- ⑥ Rotary address switch, factor 10
- ⑦ Rotary address switch, factor 1

The address switches can be activated with SYCON.net version 1.351 (or higher) and can be used with firmware version 1.1 (or higher) for PROFIBUS DP Slave, DeviceNet Slave, CANopen Slave and CC-Link Slave.

Section *Range of Values for the Address Switches* on this page lists the range of values for each protocol.

- ⑧ LED, green, LINK at X3
- ⑨ LED, yellow, ACT respectively Rx/Tx (activity) at X3

Figure 3: LEDs and Control Elements

### 4.2.1 Range of Values for the Address Switches

Protocol	Valid range of values		
PROFIBUS DP Slave	0 ... 99 (station address)		
DeviceNet Slave	0 ... 63 (MAC ID)		
CANopen Slave	0 ... 99 (Node ID)		
Protocol	Valid range of values	Number of Stations	
CC-Link Slave	1 ... 64	1	The number of stations depends on the configuration
	1 ... 63	2	
	1 ... 62	3	
	1 ... 61	4	

Figure 4: Range of Values for the Address Switches



## 4.3 Connections

### 4.3.1 X1 Top Connection

The power supply of the netTAP 50 device has to be connected to the power connector X1 . The power supply voltage must be in the range between 18 V and 30 V DC. The plug is included in delivery.

#### Supply Voltage Pin Assignment

Supply Voltage	Pin	Signal	Description
 Mini Combicon	1	0 V / GND	Ground of supply voltage
	2	24 V	+24 V supply voltage

Table 18: Supply Voltage Pin Assignment

### 4.3.2 X2 Front Connection

#### 4.3.2.1 X2 for Device Type NT 50-CO-xx

#### CANopen Pin Assignment

CANopen	Pin	Signal	Description
 9-pole sub-D male	2	CAN L	CANbus L bus line
	3	ISO GND	CAN ground
	7	CAN H	CAN bus H bus line

Table 19: CANopen Pin Assignment

Please note the wiring instructions in section *CANopen* on page 73.

#### 4.3.2.2 X2 for Device Type NT 50-CC-xx

#### CC-Link Pin Assignment

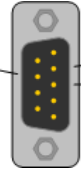
CC-Link	Pin	Signal	Description
 Socket, female	1	DA	Data positive
	2	DB	Data negative
	3	DG	Data ground
	4	SLD	Shield, internally connected to common ground
	5	FG	Field ground, internally connected to common ground

Table 20: CC-Link Pin Assignment

Please note the wiring instructions in section *CC-Link* on page 76.

**4.3.2.3 X2 for Device Type NT 50-DN-xx**

**DeviceNet Pin Assignment**

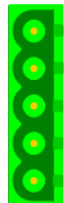
DeviceNet	Pin	Signal	Description
 COMBICON Socket, female	1	ISO GND	Common ground DeviceNet-power supply.
	2	CAN L	CAN Low signal
	3	Drain	Shield
	4	CAN H	CAN High signal
	5	V+	+24 V DeviceNet-power supply

Table 21: DeviceNet Pin Assignment

Please note the wiring instructions in section *DeviceNet* on page 74.

**4.3.2.4 X2 for Device Type NT 50-DP-xx**

**RS-485 PROFIBUS Pin Assignment**

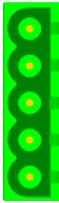
PROFIBUS	Pin	Signal	Description
 9-pole sub-D socket, female	3	Rx/Tx +	Receive- / Transmit data positive
	4	CNTR-P	Control signal for repeater (direction control)
	5	ISO GND	Data ground
	6	VP	Power supply positive
	8	Rx/Tx -	Receive- / Transmit data negative

Table 22: PROFIBUS RS-485 Pin Assignment

A pull up resistor of 100 kΩ is connected device internally at “Rx / Tx +”.  
 A pull down resistor of 100 kΩ is connected device internally at “Rx / Tx -”.  
 Please note the wiring instructions in section *PROFIBUS* on page 71.

### 4.3.2.5 X2 for Device Type NT 50-RS-EN

#### RS-232 Pin Assignment

RS-232	Pin	Signal	Description
 <p>9-pole sub-D socket, male</p>	1	GND	Reference potential, ground of power supply
	6	RxD	Receive data
	8	TxD	Transmit data

Table 23: RS-232 Pin Assignment

Please note the wiring instructions in section RS-232 on page 78.

#### RS-422 Pin Assignment

RS-422	Pin	Signal	Description
 <p>9-pole sub-D socket, male</p>	1	GND	Reference potential, ground of power supply
	4	RxD +	Receive data positive
	5	RxD -	Receive data negative
	6	TxD +	Transmit data positive
	8	TxD -	Transmit data negative

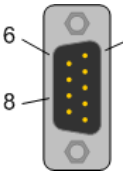
Table 24: RS-422 Pin Assignment

A pull up resistor of 10 kΩ is connected device internally at “RxD +”.  
 A pull down resistor of 10 kΩ is connected device internally at “RxD -”.  
 Please note the wiring instructions in section RS-422 on page 79.

#### RS-485 Pin Assignment

RS-485	Pin	Signal	Description
 <p>9-pole sub-D socket, male</p>	1	GND	Reference potential, ground of power supply
	4	RxD/TxD+	Receive data / Transmit data positive
	5	RxD/TxD-	Receive data / Transmit data negative

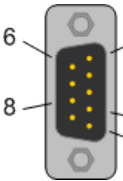
Table 25: RS-485 Pin Assignment

A pull up resistor of 10 kΩ is connected device internally at “RxD/TxD +”.  
 A pull down resistor of 10 kΩ is connected device internally at “RxD/TxD -”.  
 Please note the wiring instructions in section RS-485 on page 81.

### 4.3.3 X3 Bottom Connection

#### 4.3.3.1 X3 for Device Type NT 50-xx-EN

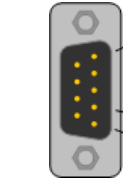
##### Ethernet on RJ45 Pin Assignment

Ethernet	Pin	Signal	Description
 <p>RJ45 socket, female</p>	1	TX+	Transmit data positive
	2	TX-	Transmit data negative
	3	RX+	Receive data positive
	4	Term 1	Connected and terminated to PE via RC combination*
	5	Term 1	
	6	RX-	Receive data negative
	7	Term 2	Connected and terminated to PE via RC combination*
	8	Term 2	
			* Bob Smith Termination

Table 26: Ethernet RJ45 Pin Assignment



**Important:** Please note for the use of hubs and switches the wiring instructions in section *Ethernet* on page 70.

#### 4.3.3.2 X3 for Device Type NT 50-xx-RS

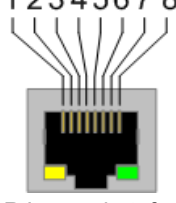
For this device type, the Ethernet interface is required for the configuration of the device. It may be necessary for diagnostic purpose to use a Y cable, which separates the serial interface (RS) and the Ethernet interface.



**NOTICE**

**Device Damage!**

- Make sure that the NT 50 device and the remote device (via RS-232, RS-422 respectively RS-485) have the same potential. Otherwise a compensating current may cause device damage, because the serial interface of the NT 50 device has no galvanic isolation to its power supply.



**NOTICE**

**Device Damage!**

- Make sure that only a 4-wire Ethernet cable is used (with pin 1, 2, 3 and 6), if no Y cable for separation of the Ethernet and serial interface is used. On pin 4, 5, 7 and 8 on the NT 50 device are the signals for the serial interface. If you transfer these signal via an Ethernet cable to the connected device (e. g. to a switch) this may cause a device damage of the used devices.

**RS-232 and Ethernet on RJ45 Pin Assignment**

Ethernet	Pin	Signal	Description
 <p>RJ45 socket, female</p>	1	<b>Ethernet TX+</b>	Transmit data positive *
	2	<b>Ethernet TX-</b>	Transmit data negative *
	3	<b>Ethernet RX+</b>	Receive data positive *
	4	<b>RS232 3,3 V</b>	Data potential 'High', not usable as power supply. Ri appr. 300 Ω.
	5	<b>RS232 GND</b>	Data reference potential, ground of power supply
	6	<b>Ethernet RX-</b>	Receive data negative *
	7	<b>RS232 TxD</b>	Transmit data
	8	<b>RS232 RxD</b>	Receive data
		PE	Metal case on PE
			* Bob Smith Termination

Table 27: RJ45 Ethernet / RS-232 Pin Assignment



**RS-422 and Ethernet on RJ45 Pin Assignment**

Ethernet	Pin	Signal	Description
 <p>RJ45 socket, female</p>	1	<b>Ethernet TX+</b>	Transmit data positive *
	2	<b>Ethernet TX-</b>	Transmit data negative *
	3	<b>Ethernet RX+</b>	Receive data positive *
	4	<b>RS422 RxD -</b>	Receive data negative
	5	<b>RS422 RxD +</b>	Receive data positive
	6	<b>Ethernet RX-</b>	Receive data negative *
	7	<b>RS422 TxD -</b>	Transmit data negative
	8	<b>RS422 TxD +</b>	Transmit data positive
	PE		Metal housing on PE
			* Bob Smith Termination

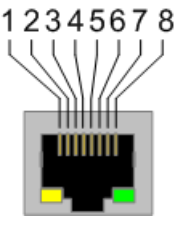
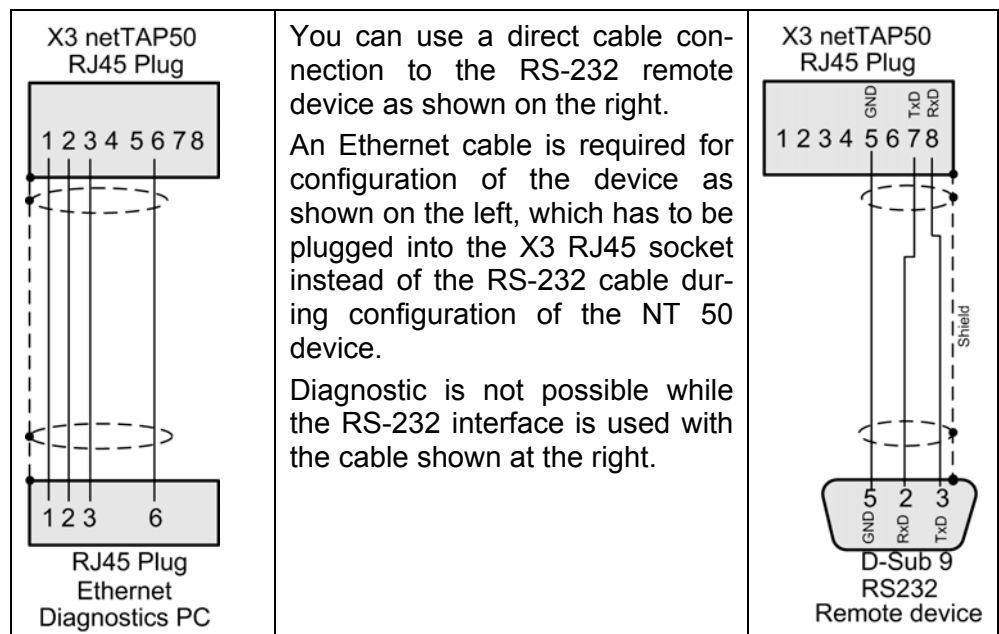
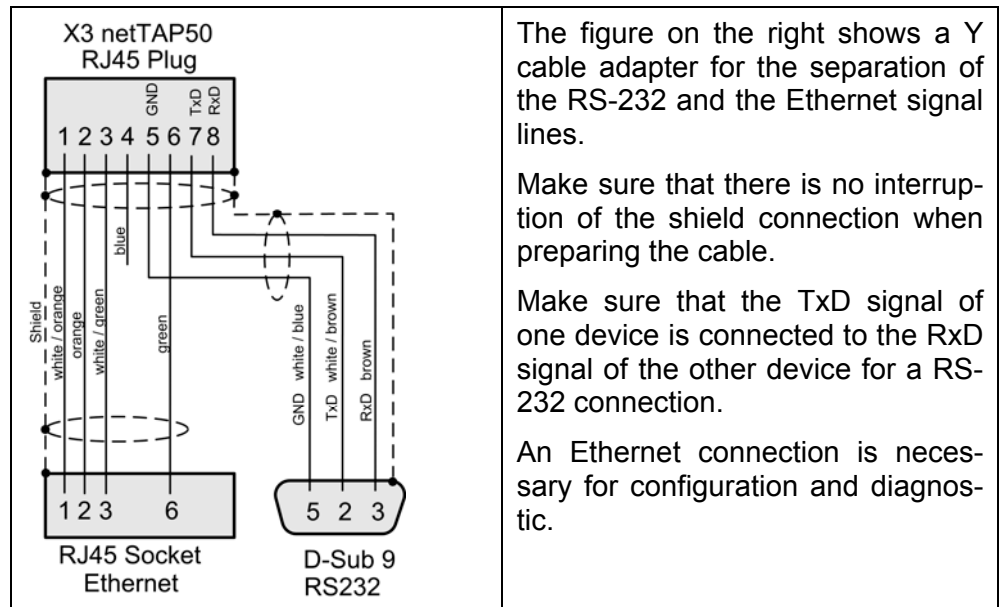
Table 28: RJ45 Ethernet / RS-422 Pin Assignment



The figure on the right shows a Y cable adapter for the separation of the RS-422 and the Ethernet signal lines.

Make sure that there is no interruption of the shield connection when preparing the cable.

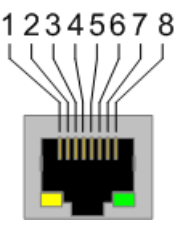
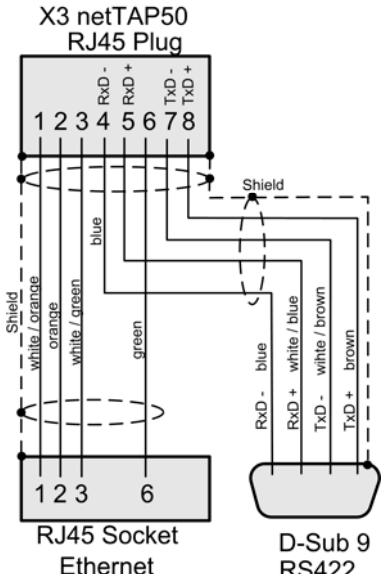
Make sure that the TxD+ signal of one device is connected to the RxD+ signal of the other device for a RS-422 connection. Make sure that the TxD- signal of one device is connected to the RxD- signal of the other device for a RS-422 connection.

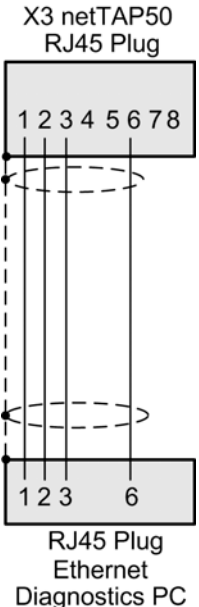

You can use a direct cable connection to the RS-422 remote device as shown on the right.

An Ethernet cable is required for configuration of the device as shown on the left, which has to be plugged into the X3 RJ45 socket instead of the RS-422 cable during configuration of the NT 50 device.

Diagnostic is not possible while the RS-422 interface is used with the cable shown at the right.

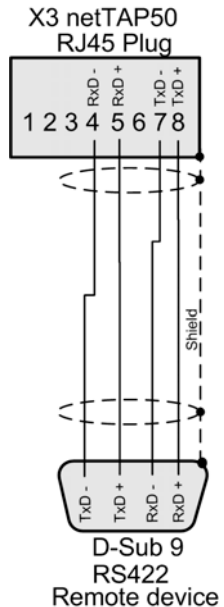

**RS-485 and Ethernet on RJ45 Pin Assignment**

Ethernet	Pin	Signal	Description
 <p>RJ45 socket, fe- male</p>	1	<b>Ethernet TX+</b>	Transmit data positive *
	2	<b>Ethernet TX-</b>	Transmit data negative
	3	<b>Ethernet RX+</b>	Receive data positive *
	4	<b>RS485 RxD/TxD -</b>	Receive data / Transmit data negative
	5	<b>RS485 RxD/TxD +</b>	Receive data / Transmit data positive
	6	<b>Ethernet RX-</b>	Receive data negative *
	7		not used
	8		not used
	PE		metal housing on PE
			* Bob Smith Abschluss

Table 29: RJ45 Ethernet / RS-485 Pin Assignment



The figure on the right shows a Y cable adapter for the separation of the RS-485 and the Ethernet signal lines.

Make sure that there is no interruption of the shield connection when preparing the cable.

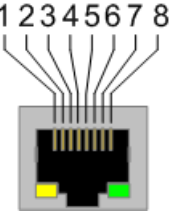
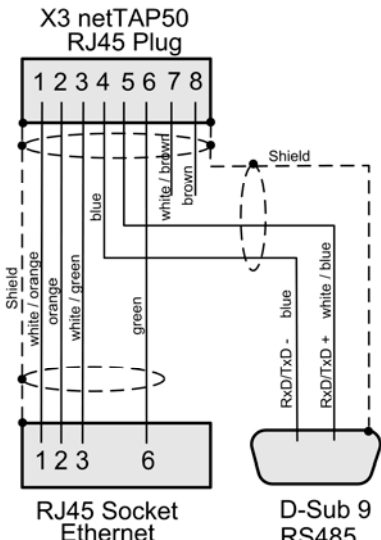
Make sure that the RxD/TxD+ signal of one device is connected to the RxD/TxD+ signal of the other device for a RS-485 connection. Make sure that the RxD/TxD- signal of one device is connected to the RxD/TxD- signal of the other device for a RS-485 connection.

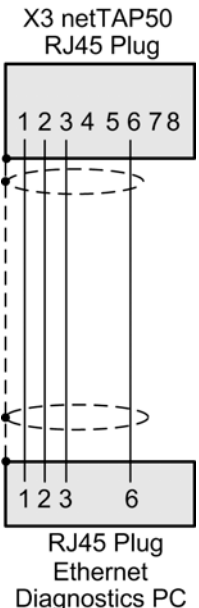

You can use a direct cable connection to the RS-485 remote device as shown on the right.

An Ethernet cable is required for configuration of the device as shown on the left, which has to be plugged into the X3 RJ45 socket instead of the RS-485 cable during configuration of the NT 50 device.

Diagnostic is not possible while the RS-485 interface is used with the cable shown at the right.

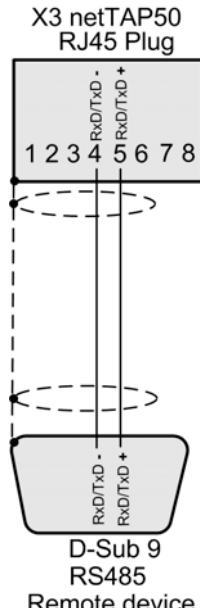

## 4.4 Schematic Diagram - Galvanic Isolation

The following schematic diagrams illustrate the internal connection between the different connectors. This gives you the chance to properly install the device in accordance with the potential equalization concept of your plant.



**Note:** The PE connection (potential equalization) of the device is done via the DIN rail.

### 4.4.1 Galvanic Isolation of NT 50-xx-EN Devices

The device types NT 50-CC-EN, NT 50-CO-EN, NT 50-DN-EN and NT 50-DN-EN has three galvanically isolated areas. The coupling to PE is shown in the following figure and in the following table.

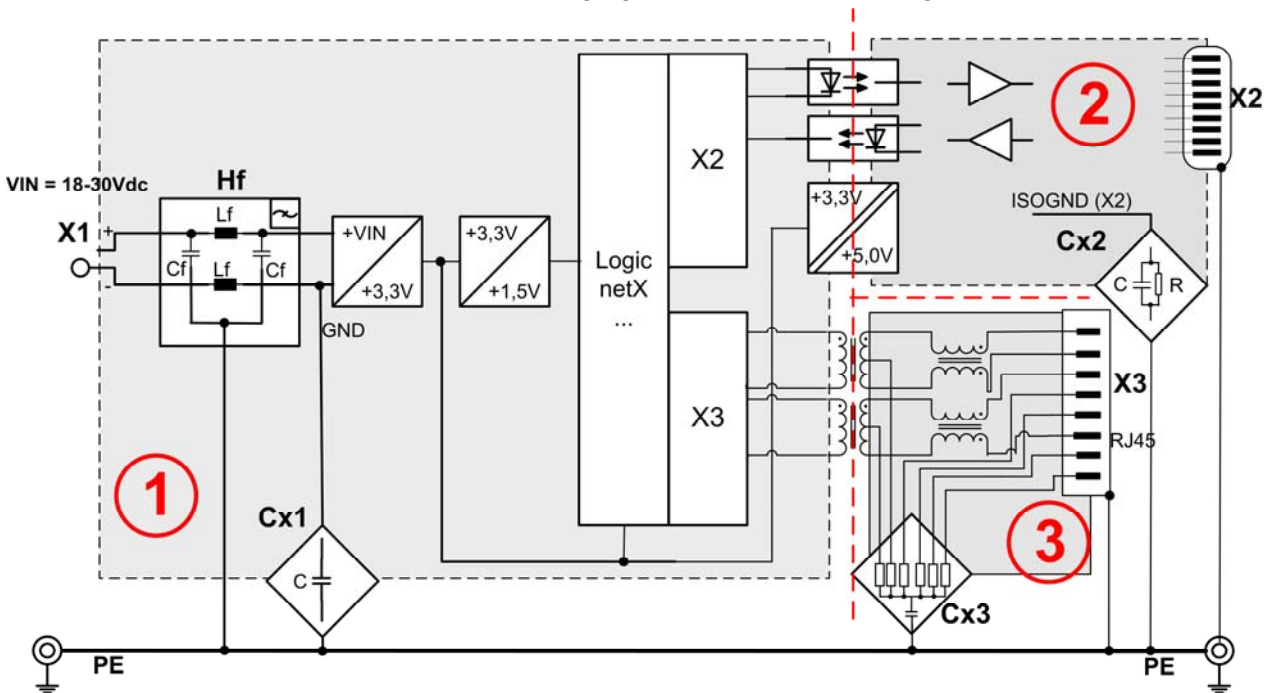

Figure 5: Galvanic Isolation of NT 50-xx-EN Devices

Area Con- nection	Protocol	galv. Iso- lation	Coupling	Coupling against PE potential	Functional earthing to PE
① X1	-	no	HF ①	$C_f = 10 \text{ nF} / 500 \text{ V}$ , $L_f = 47 \text{ } \mu\text{H}$	-
			Cx1 ①	$4 * 10 \text{ nF} / 500 \text{ V}$	
② X2	CC-Link	inductive	Cx2 ②	$3,3 \text{ nF} / 1000 \text{ V}$	directly to Combicon Pin 4
	CANopen	optically	Cx2 ②	$1 \text{ M}\Omega // 15 \text{ nF} / 1000 \text{ V}$	directly via the metal con- nection of the D-Sub-male connector
	DeviceNet	optically	Cx2 ②	$1 \text{ M}\Omega // 15 \text{ nF} / 1000 \text{ V}$	$1 \text{ M}\Omega // 15 \text{ nF} 1000 \text{ V}$ Combicon Pin 3
	Profibus DP	inductive	Cx2 ②	$1 \text{ M}\Omega // 2,2 \text{ nF} / 1000 \text{ V}$	directly via the metal con- nection of the D-Sub female connector
③ X3	Ethernet	inductive	Cx3 ③	$6 * 75 \Omega, 1 \text{ nF} / 2000 \text{ V}$	Directly via the metal con- nection of RJ 45 sockets

Table 30: Coupling NT 50-xx-EN Devices



### 4.4.2 Galvanic Isolation of NT 50-xx-RS

The device types NT 50-CC-RS, NT 50-CO-RS, NT 50-DN-RS and NT 50-DN-RS has three galvanically isolated areas. The coupling to PE is shown in the following figure and in the following table.

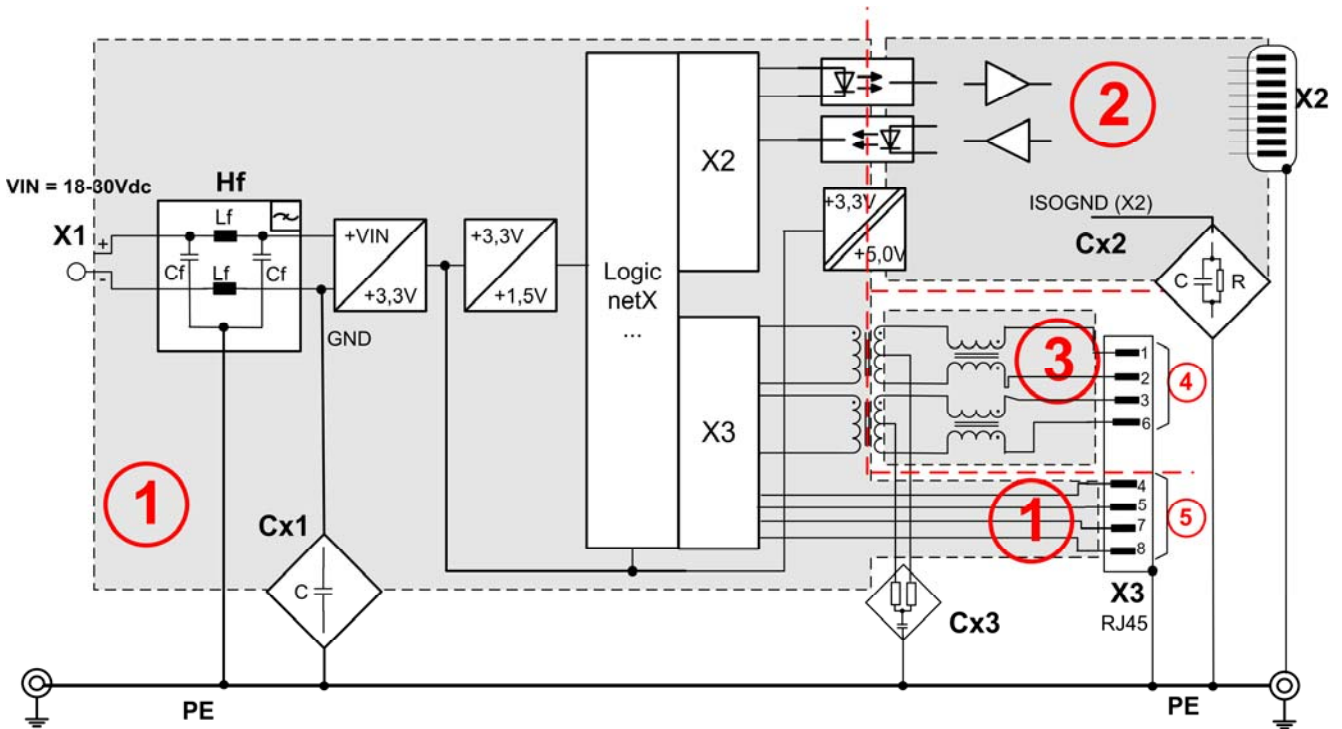

Figure 6: Galvanic Isolation of NT 50-xx-RS Devices

Area Connection	Protocol	galv. Isolation	Coupling	Coupling against PE potential	Functional earthing to PE
① X1	-	no	HF ①	$C_f = 10 \text{ nF} / 500 \text{ V}$ , $L_f = 47 \text{ } \mu\text{H}$	no
			Cx1 ①	$4 * 10 \text{ nF} / 500 \text{ V}$	
② X2	CC-Link	inductive	Cx2 ②	$3,3 \text{ nF} / 1000 \text{ V}$	directly
	CANopen	optisch	Cx2 ②	$1 \text{ M}\Omega // 15 \text{ nF} / 1000 \text{ V}$	directly via the metal connection of the D-Sub male connector
	DeviceNet	optically	Cx2 ②	$1 \text{ M}\Omega // 15 \text{ nF} / 1000 \text{ V}$	Combicon Pin 3 $1 \text{ M}\Omega // 15 \text{ nF} / 1000 \text{ V}$
	Profibus DP	inductive	Cx2 ②	$1 \text{ M}\Omega // 2,2 \text{ nF} / 1000 \text{ V}$	directly via the metal connection of the D-Sub female connector
③ X3 Teil ④	Ethernet, only for diagnostic	inductive	Cx3 ③	$2 * 75 \Omega, 1 \text{ nF} / 2000 \text{ V}$	Directly via the metal connection of RJ 45 sockets
① X3 Teil ⑤	RS232 RS422 RS485	 no			Directly via the metal connection of RJ 45 sockets

Table 31: Coupling NT 50-xx-RS Devices

### 4.4.3 Galvanic Isolation of NT 50-RS-EN

The device type NT 50-RS-EN has three galvanically isolated areas. The coupling to PE is shown in the following figure and in the following table.

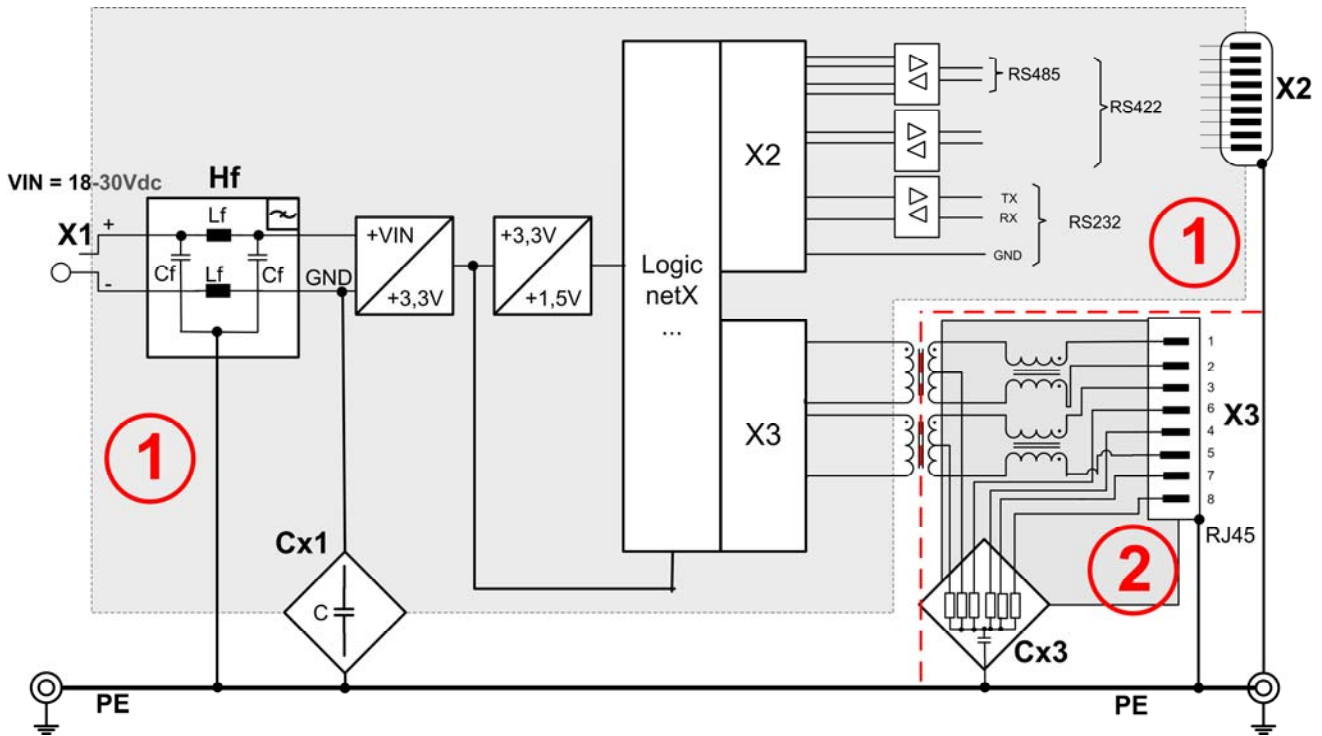

Figure 7: Galvanic Isolation of NT 50 -RS-EN Devices

Area Connection	Protocol	galv. Isolation	Coupling	Coupling against PE potential	Functional earthing to PE
① X1	-	no	HF ①	$C_f = 10 \text{ nF} / 500 \text{ V}$ , $L_f = 47 \text{ } \mu\text{H}$	no
			Cx1 ①	$4 * 10 \text{ nF} / 500 \text{ V}$	
① X2	RS232 RS422 RS485	⚠ no	HF ①	$C_f = 10 \text{ nF}$ , $L_f = 47 \text{ } \mu\text{H}$	directly via the metal connection of the D-Sub female connector
			Cx1 ①	$4 * 10 \text{ nF} / 500 \text{ V}$	
② X3	Ethernet	inductive	Cx3 ②	$6 * 75 \Omega + 10 \text{ nF} / 2000 \text{ V}$	Directly via the metal connection of RJ 45 sockets

Table 32: Coupling NT 50-RS-EN Devices

## 5 NT 50 Mounting and Dismounting

The devices can be mounted side-by-side without any gap. On the top side, the devices should have a minimum distance of 20 mm to the next device.

The air ventilation slots of the device must not be covered by any objects.

### 5.1 DIN Top Hat Rail Mounting of the NT 50

Mount the top hat rail according to DIN EN 60715 for the netTAP device horizontally at the intended location. The DIN top hat rail has to be connected with the potential equalization conductor (PE).

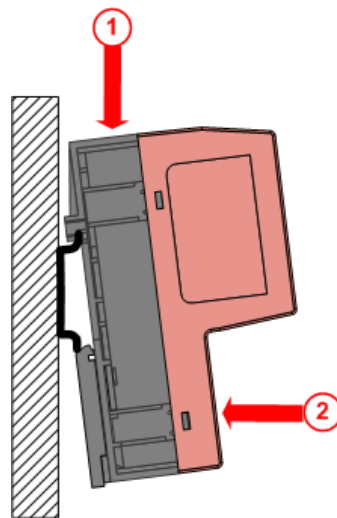

Push the device onto the top hat rail from above **1**.

Then press the device against the mounting surface, according to arrow **2**.

Figure 8: Mounting the netTAP NT 50 device onto the top-hat rail

Afterwards connect the 24 V supply voltage to the device. Grounding is done via a grounding contact located at the backside of the device connecting it electrically to the top-hat rail.

### 5.2 Removing the NT 50 from the DIN Top Hat Rail

In order to remove the netTAP from the top-hat rail, first remove the power supply cable and all data cables from the device.

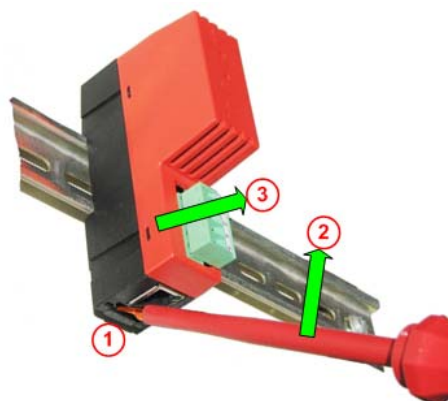

To release the device from the top-hat rail, use a screw driver, which you put at the clip **1** in the center of the device. By pressing slightly the screw driver in direction of arrow **2** the lock at the top-hat rail is released. You can then easily pull the device off the top-hat rail in direction of arrow **3**.

Figure 9: Removing the NT 50 device from the Top-Hat Rail

## 6 Commissioning

### 6.1 Load Firmware and Configuration

The device delivered without loaded firmware and configuration.

It is necessary that a firmware and configuration is loaded into the device for commissioning.

The device can be configured before or after mounting via the RJ45 Ethernet interface at the bottom of the device. A PC with SYCON.net software is necessary for configuration.

For communication from SYCON.net software to the netTAP NT 50 device via Ethernet, it is necessary to assign an IP address to the netTAP NT 50 device. This is done with the Ethernet Device Setup Software, which is installed together with SYCON.net software.



Information about this is in the manual „netGateway\_DTM\_en.pdf“ on the product DVD in the directory „Documentation“.



**Note:** The IP address, which was set with the Ethernet Device Setup Software, is set permanently. A PROFINET IO Controller may change this IP address.

#### 6.1.1 Download Configuration Files from the PC

1. The configuration can be created and saved offline with or without real device on a standard PC with the software SYCON.net. The configuration can be downloaded into the device in two steps afterwards
2. The selected firmware and configuration has to be transferred in two steps via an Ethernet connection into the device.  
The configuration is stored in the device in a non-volatile flash memory. Once set the data will be available after each power cycle.  
These steps are described in the operating instruction manual netGateway.

So it is possible to transfer the configuration into the device before or after mounting the device at its place of use.



Information about this is in the manual *netGateway DTM OI xx EN.pdf* on the product DVD in the directory „Documentation“.



**Important:** Do not interrupt the communication during the download of the firmware into the netTAP NT 50 device.

If the communication to the netTAP NT 50 device is interrupted during download of the firmware, the power supply for the device must not switch off till the next complete download of the firmware into the device, because otherwise the functionality of the device is destroyed. Then the device has to be send back for repair to the manufacturer.

## 6.1.2 Potential Differences for Device Types NT 50-xx-RS

---



### NOTICE

#### Device Destruction!

Make sure that for the NT 50-xx-RS device and the remote device (via RS-232, RS-422 respectively RS-485) have the same potential. Otherwise a compensating current may cause device damage, because the serial interface of the NT 50 device has no galvanic isolation to its power supply.

---

## 6.2 Start-up Behavior

The firmware and the configuration data are loaded from the FLASH memory into the RAM of the NT 50 device after return of the power supply and subsequently the firmware is started. This process can take several seconds (appr. 4 seconds) depending on the size of the configuration data.

## 7 Troubleshooting

Two methods for troubleshooting exist:

- The visual analysis of the LED conditions of the device
- The analysis via the Ethernet port along with the configuration tool SYCON.net.

The following overview describes the error conditions that may be detected by a visual check of the LEDs.

In order to find the correct position of the LEDs please follow the chapter *Positions of LEDs and Control Elements* from page 24. The numbers in the column LED state is referencing the position number in the device drawing.







LED state	Remedy
No LED is on	The device is not powered or the device has a malfunction and needs replacement.
SYS LED ① flashes  yellow/green at 1 Hz	After a power cycle the device has not found a valid firmware and remains in bootloader mode. The device has to be send back to the manufacturer for repair.
SYS LED ① is permanent  yellow	The device has a malfunction and needs replacement.
SYS LED ① flashes  yellow after Power On	The device has not found a firmware. The device has to be send back to the manufacturer for repair.
SYS LED ① is permanent  green, APL LED ② on  red flashing or red on	The device is well initialized. Further analysis is possible with the LED ② APL. Follow the chapter <i>System LEDs</i> on page 40.
APL LED ② flashing  green	The communication via port X2 or/and port X3 is not in data exchange mode. See chapter <i>System LEDs</i> on page 40.

Table 33: NT 50 Troubleshooting

The device is operational just in case the illustrated error conditions do not met. Further protocol specific error diagnostics via the LEDs is possible by reading on the chapter “LEDs”

In deep diagnostics is possible at any time via the Ethernet diagnostic port of the device and a PC with the software SYCON.net.

In case of trouble you should make sure that you have downloaded a correct signal mapping to the device via SYCON.net

For some protocols it is necessary to synchronize data via a handshake between the gateway and the superordinated PLC. Please make sure that the handshake mechanism is kept.

## 7.1 Failure in 10 MBit/s Half Duplex Mode and Workaround

Only devices NT 50-xx-EN respectively NT 50 xx-RS are affected that were produced before 2011 and have a serial number below the serial number listed in the following table:

Device Type NT 50	Serial Number below
NT 50-CC-EN	20023
NT 50-CC-RS	20022
NT 50-CO-EN	20023
NT 50-CO-RS	20019
NT 50-DN-EN	20019
NT 50-DN-RS	20019
NT 50-DP-EN	20025
NT 50-DP-RS	20026
NT 50-RS-EN	20023

### Affected Hardware

Hardware with the communication controller netX 50, netX 100 or netX 500; netX/Internal PHYs.

### When can this Failure occur?

When using standard Ethernet communication with 10 MBit/s half duplex mode, the PHY gets stuck in case of network collisions. Then no further network communication is possible. Only device power cycling allows Ethernet communication again.

This problem can only occur with Ethernet TCP/UDP IP, EtherNet/IP or Modbus TCP protocols when using hubs at 10 MBit/s. The issue described above is not applicable for protocols which use 100 MBit/s or full duplex mode.

### Solution / Workaround:

Do not use 10 MBit/s-only hubs. Use either switches or 10/100 MBit/s Dual Speed hubs, to make sure the netX Ethernet ports are connected with 100 MBit/s or in full duplex mode.

This erratum is fixed with all components of the ‘Y’ charge (9 digit charge number shows ‘Y’ at position 5 (nnnnYnnnn)).

### Reference

“Summary of 10BT problem on EthernetPHY”,  
 RenesasElectronics Europe, April 27, 2010

# 8 LEDs

## 8.1 System LEDs

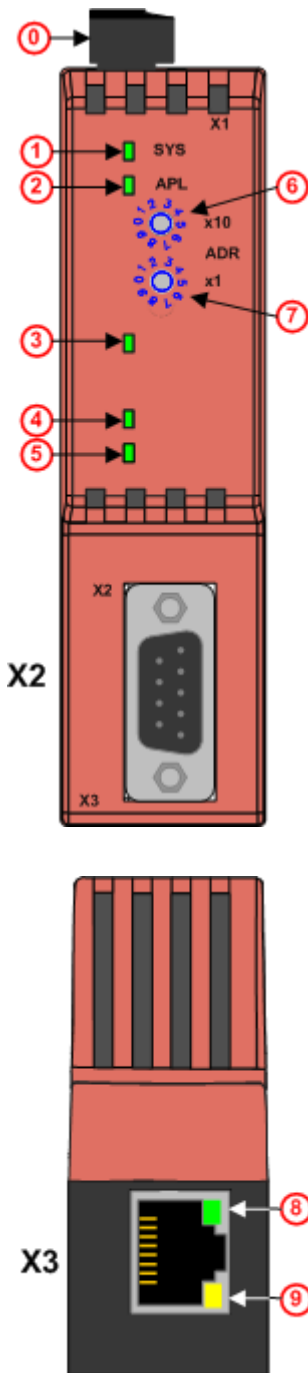

LED	Color	State	Meaning
SYS ①	Duo LED yellow/green		
	(green)	On	Operating System running. further diagnostic see APL LED.
	(yellow)	On	This state may occur only briefly. If this LED stays permanently yellow, then a hardware failure is possible.
	(yellow/green)	Flashing yellow/green	<b>Error state!</b> Boot loader active.
	(off)	Off	Power supply for the device is missing or hardware failure.

LED	Color	State	Meaning
APL ②	Duo LED red/green		
	(green)	On	The communication on X2 and X3 is in cyclic data exchange and the gateway function is executed
	(green)	Blinking with 2 s off, 0,5 s on	netTAP is initialized, but the communication on X2 is not in cyclic data exchange.
	(green)	Blinking with 2 s off, 0,5 s on, 0,5 s off, 0,5 s on,	netTAP is initialized, but the communication on X3 is not in cyclic data exchange.
	(red)	Blinking with 2 s off, 0,5 s on	netTAP is initialized, but the configuration for the communication protocol on X2 is missing or has an error
	(red)	Blinking with 2 s off, 0,5 s on, 0,5 s off, 0,5 s on,	netTAP is initialized, but the configuration for the communication protocol on X3 is missing or has an error
(red)	On	netTAP has detected an error during the initialization: Missing configuration, error in configuration or internal error	

Figure 10: LEDs



## 8.2 LEDs Real Time Ethernet Protocols

### 8.2.1 LEDs EtherNet/IP Scanner (Master)

The subsequent table describes the meaning of the LEDs for the Real-Time Ethernet device when the firmware of the EtherNet/IP Scanner (Master) protocol is loaded to the device.



















LED	Color	State	Meaning
<b>MS</b> Number in the device drawing: 	<b>Duo LED red/green</b>		
	 (green)	On	<b>Device operational:</b> If the device is operating correctly, the module status indicator shall be steady green.
	 (green)	Flashing	<b>Standby:</b> If the device has not been configured, the module status indicator shall be flashing green.
	 (red)	On	<b>Major fault:</b> If the device has detected a non-recoverable major fault, the module status indicator shall be steady red.
	 (red)	Flashing	<b>Minor fault:</b> If the device has detected a recoverable minor fault, the module status indicator shall be flashing red. NOTE: An incorrect or inconsistent configuration would be considered a minor fault.
	 (red/green)	Flashing	<b>Self-test:</b> While the device is performing its power up testing, the module status indicator shall be flashing green/red.
	 (off)	Off	<b>No power:</b> If no power is supplied to the device, the module status indicator shall be steady off.
<b>NS</b> Number in the device drawing: 	<b>Duo LED red/green</b>		
	 (green)	On	<b>Connected:</b> If the device has at least one established connection (even to the Message Router), the network status indicator shall be steady green.
	 (green)	Flashing	<b>No connections:</b> If the device has no established connections, but has obtained an IP address, the network status indicator shall be flashing green.
	 (red)	On	<b>Duplicate IP:</b> If the device has detected that its IP address is already in use, the network status indicator shall be steady red.
	 (red)	Flashing	<b>Connection timeout:</b> If one or more of the connections in which this device is the target has timed out, the network status indicator shall be flashing red. This shall be left only if all timed out connections are reestablished or if the device is reset.
	 (red/green)	Flashing	<b>Self-test:</b> While the device is performing its power up testing, the network status indicator shall be flashing green/red.
	 (off)	Off	<b>Not powered, no IP address:</b> If the device does not have an IP address (or is powered off), the network status indicator shall be steady off.
<b>LINK/RJ45</b> Number in the device drawing: 	<b>LED green</b>		
	 (green)	On	A connection to the Ethernet exists
	 (off)	Off	The device has no connection to the Ethernet
<b>ACT/RJ45</b> Number in the device drawing: 	<b>LED yellow</b>		
 (yellow)	Flashing	The device sends/receives Ethernet frames	

Table 34: LEDs EtherNet/IP Scanner (Master)

## 8.2.2 LEDs EtherNet/IP Adapter (Slave)

The subsequent table describes the meaning of the LEDs for the Real-Time Ethernet device when the firmware of the EtherNet/IP Adapter (Slave) protocol is loaded to the device.















LED	Color	State	Meaning
<b>MS</b> Number in the device drawing: <span style="border: 1px solid red; border-radius: 50%; padding: 2px;">4</span>	<b>Duo LED red/green</b>		
	 (green)	On	<b>Device operational:</b> If the device is operating correctly, the module status indicator shall be steady green.
	 (green)	Flashing	<b>Standby:</b> If the device has not been configured, the module status indicator shall be flashing green.
	 (red)	On	<b>Major fault:</b> If the device has detected a non-recoverable major fault, the module status indicator shall be steady red.
	 (red)	Flashing	<b>Minor fault:</b> If the device has detected a recoverable minor fault, the module status indicator shall be flashing red. NOTE: An incorrect or inconsistent configuration would be considered a minor fault.
	 (red/green)	Flashing	<b>Self-test:</b> While the device is performing its power up testing, the module status indicator shall be flashing green/red.
	 (off)	Off	<b>No power:</b> If no power is supplied to the device, the module status indicator shall be steady off.
<b>NS</b> Number in the device drawing: <span style="border: 1px solid red; border-radius: 50%; padding: 2px;">5</span>	<b>Duo LED red/green</b>		
	 (green)	On	<b>Connected:</b> If the device has at least one established connection (even to the Message Router), the network status indicator shall be steady green.
	 (green)	Flashing	<b>No connections:</b> If the device has no established connections, but has obtained an IP address, the network status indicator shall be flashing green.
	 (red)	On	<b>Duplicate IP:</b> If the device has detected that its IP address is already in use, the network status indicator shall be steady red.
	 (red)	Flashing	<b>Connection timeout:</b> If one or more of the connections in which this device is the target has timed out, the network status indicator shall be flashing red. This shall be left only if all timed out connections are reestablished or if the device is reset.
	 (red/green)	Flashing	<b>Self-test:</b> While the device is performing its power up testing, the network status indicator shall be flashing green/red.
	 (off)	Off	<b>Not powered, no IP address:</b> If the device does not have an IP address (or is powered off), the network status indicator shall be steady off.
<b>LINK/RJ45</b> Number in the device drawing: <span style="border: 1px solid red; border-radius: 50%; padding: 2px;">8</span>	<b>LED green</b>		
	 (green)	On	A connection to the Ethernet exists
	 (off)	Off	The device has no connection to the Ethernet
<b>ACT/RJ45</b> Number in the device drawing: <span style="border: 1px solid red; border-radius: 50%; padding: 2px;">9</span>	<b>LED yellow</b>		
	 (yellow)	Flashing	The device sends/receives Ethernet frames

Table 35: LEDs EtherNet/IP Adapter (Slave)

### 8.2.3 LEDs Open Modbus/TCP

The subsequent table describes the meaning of the LEDs for the Real-Time Ethernet device when the firmware of the Open Modbus/TCP protocol is loaded to the device.











LED	Color	State	Meaning
<b>RUN</b> Number in the device drawing <b>4</b>	<b>Duo LED red/green</b>		
	 (off)	Off	<b>Not Ready</b> OMB task is not ready
	 (green)	Flashing cyclic with 1Hz	<b>Ready, not configured yet</b> OMB task is ready and not configured yet
	 (green)	Flashing cyclic with 5Hz	<b>Waiting for Communication:</b> OMB task is configured
	 (green)	On	<b>Connected:</b> OMB task has communication – at least one TCP connection is es- tablished
<b>ERR</b> Number in the device drawing: <b>5</b>	<b>Duo LED red/green</b>		
	 (off)	Off	No communication error
	 (red)	Flashing cyclic with 2Hz (On/Off Ratio = 25 %)	System error
	 (red)	On	Communication error active
<b>LINK/RJ</b> Number in the device drawing: <b>8</b>	<b>LED green</b>		
	 (green)	On	A connection to the Ethernet exists
	 (off)	Off	The device has no connection to the Ethernet
<b>ACT/RJ</b> Number in the device drawing: <b>9</b>	<b>LED yellow</b>		
	 (yellow)	Flashing	The device sends/receives Ethernet frames

Table 36: LEDs Open Modbus/TCP

## 8.2.4 LEDs PROFINET IO Controller

The subsequent table describes the meaning of the LEDs for the Real-Time Ethernet device when the firmware of the PROFINET IO-RT Controller protocol is loaded to the device.









LED	Color	State	Meaning
<b>SF</b> Name in the device drawing: ④	<b>Duo LED red/green</b>		
	 (red)	On	<b>(together with BF „red ON“)</b> <b>No valid Master license</b>
	 (red)	Flashing cyclic at 2 Hz	<b>System error:</b> Invalid configuration, Watchdog error or internal error
	 (off)	Off	No error
<b>BF</b> Name in the device drawing: ⑤	<b>Duo LED red/green</b>		
	 (red)	On	<b>No Connection:</b> No Link. or <b>(together with SF „red ON“)</b> <b>No valid Master license</b>
	 (red)	Flashing cyclic at 2 Hz	<b>Configuration fault:</b> not all configured IO-Devices are connected.
<b>LINK</b> RJ45 ⑧	<b>LED green</b>		
	 (green)	On	A connection to the Ethernet exists
	 (off)	Off	The device has no connection to the Ethernet
<b>RX/TX</b> RJ45 ⑨	<b>LED yellow</b>		
	 (yellow)	Flashing	The device sends/receives Ethernet frames

Table 37: LEDs PROFINET IO-RT Controller

## 8.2.5 LEDs PROFINET IO-RT-Device

The subsequent table describes the meaning of the LEDs for the Real-Time Ethernet device when the firmware of the PROFINET IO-RT-Device protocol is loaded to the device.









LED	Color	State	Meaning
<b>SF</b> Number in the device drawing: <b>4</b>	<b>Duo LED red/green</b>		
	 (red)	On	Watchdog timeout; channel, generic or extended diagnosis present; system error
	 (red)	Flashing cyclic at 2 Hz (for 3 sec.)	DCP signal service is initiated via the bus
	 (off)	Off	No error
<b>BF</b> Number in the device drawing: <b>5</b>	<b>Duo LED red/green</b>		
	 (red)	On	No configuration; or low speed physical link; or no physical link
	 (red)	Flashing cyclic at 2 Hz	No data exchange
	 (off)	Off	No error
<b>LINK/RJ45</b> <b>8</b>	<b>LED green</b>		
	 (green)	On	A connection to the Ethernet exists
	 (off)	Off	The device has no connection to the Ethernet
<b>RX/TX/RJ45</b> <b>9</b>	<b>LED yellow</b>		
	 (yellow)	Flashing	The device sends/receives Ethernet frames

Table 38: LEDs PROFINET IO-RT-Device

## 8.3 LEDs Fieldbus Protocols

### 8.3.1 LED PROFIBUS-DP Master

The subsequent table describes the meaning of the LEDs for the cifX card fieldbus when the firmware of the PROFIBUS DP Master protocol is loaded to the device.







LED	Color	State	Meaning
<b>cifX Card with 1 Communication LED (current Hardware Revision)</b>			
<b>COM</b> 	<b>Duo LED red/green</b>		
	 (green)	Flashing acyclic	No configuration or stack error
	 (green)	Flashing cyclic	Profibus is configured, but bus communication is not yet released from the application
	 (green)	On	Communication to all Slaves is established
	 (red)	Flashing cyclic	Communication to at least one Slave is disconnected
 (red)	On	Communication to one/all Slaves is disconnected	

Table 39: LEDs PROFIBUS DP Master – 1 Communication LED

### 8.3.2 LED PROFIBUS-DP Slave

The subsequent table describes the meaning of the LED for the device when the firmware of the PROFIBUS DP Slave protocol is loaded to the device.





LED	Color	State	Meaning
<b>COM</b> 	<b>Duo LED red/green</b>		
	 (green)	On	RUN, cyclic communication.
	 (red)	On	Wrong configuration at PROFIBUS-DPside.
	 (red)	Flashing cyclic	STOP, no communication, connection error.
	 (red)	Flashing acyclic	Not configured.

Table 40: LEDs PROFIBUS DP Slave

### 8.3.3 LED CANopen Master

The subsequent table describes the meaning of the LEDs for the fieldbus device when the firmware of the CANopen Master protocol is loaded to the device.







LED	Color	State	Meaning
CAN ③	<b>Duo LED red/green</b>		
	 (off)	Off	<b>RESET:</b> The device is executing a reset
	 (green)	Single flash	<b>STOPPED:</b> The device is in STOPPED state
	 (green)	Blinking	<b>PREOPERATIONAL:</b> The device is in the PREOPERATIONAL state
	 (green)	On	<b>OPERATIONAL:</b> The device is in the OPERATIONAL state
	 (red)	Single flash	<b>Warning Limit reached:</b> At least one of the error counters of the CAN controller has reached or exceeded the warning level (too many error frames).
	 (red)	Double flash	<b>Error Control Event:</b> A guard event (NMT Slave or NMT-master) or a heartbeat event (Heartbeat consumer) has occurred.
 (red)	On	<b>Bus Off:</b> The CAN controller is bus off	

Table 41: LEDs CANopen Master

#### LED State Definition for CANopen Master for the CAN LED

Indicator state	Definition
On	The indicator is constantly on.
Off	The indicator is constantly off.
Flickering	The indicator turns on and off with a frequency of 10 Hz: on for 50 ms, followed by off for 50 ms.
Blinking	The indicator turns on and off with a frequency of 2,5 Hz: on for 200 ms, followed by off for 200 ms.
Single Flash	The indicator shows one short flash (200 ms) followed by a long off phase (1,000 ms).
Double Flash	The indicator shows a sequence of two short flashes (each 200 ms), separated by a short off phase (200 ms). The sequence is finished by a long off phase (1,000 ms).

Table 42: LED State Definition for CANopen Master for the CAN LED

### 8.3.4 LED CANopen Slave

The subsequent table describes the meaning of the LEDs for the device when the firmware of the CANopen Slave protocol is loaded to the device.









LED	Color	State	Meaning
<b>CAN</b> 	<b>Duo LED red/green</b>		
	 (off)	Off	<b>RESET:</b> The device is executing a reset
	 (green)	Single flash	<b>STOPPED:</b> The device is in STOPPED state
	 (green)	Blinking	<b>PREOPERATIONAL:</b> The device is in the PREOPERATIONAL state
	 (green)	On	<b>OPERATIONAL:</b> The device is in the OPERATIONAL state
	 (red/green)	Flickering (alternatively red / green)	<b>Auto Baud Rate Detection active:</b> The Device is in the Auto Baud Rate Detection mode
	 (red)	Single flash	<b>Warning Limit reached:</b> At least one of the error counters of the CAN controller has reached or exceeded the warning level (too many error frames).
	 (red)	Double flash	<b>Error Control Event:</b> A guard event (NMT Slave or NMT-master) or a heartbeat event (Heartbeat consumer) has occurred.
 (red)	On	<b>Bus Off:</b> The CAN controller is bus off	

Table 43: LEDs CANopen Slave

#### LED State Definition for CANopen Slave for the CAN LED

Indicator state	Definition
On	The indicator is constantly on.
Off	The indicator is constantly off.
Flickering	The indicator turns on and off with a frequency of 10 Hz: on for 50 ms, followed by off for 50 ms.
Blinking	The indicator turns on and off with a frequency of 2,5 Hz: on for 200 ms, followed by off for 200 ms.
Single Flash	The indicator shows one short flash (200 ms) followed by a long off phase (1,000 ms).
Double Flash	The indicator shows a sequence of two short flashes (each 200 ms), separated by a short off phase (200 ms). The sequence is finished by a long off phase (1,000 ms).

Table 44: LED State Definition for CANopen Slave for the CAN LED



### 8.3.5 LED DeviceNet Master

The subsequent table describes the meaning of the LEDs for the fieldbus when the firmware of the DeviceNet Master protocol is loaded to the device.







LED	Color	State	Meaning
<b>MNS</b> 	<b>Duo LED red/green</b>		
	 (green)	On	Device is online and has one or more connections in the established state
	 (green)	Flashing	Device is online and has no connection in the established state
	 (green/red/off)	Green/Red/Off	Selftest after power on: Green on for 0,25 s, then red on for 0,25 s, then off
	 (red)	Flashing	Connection timeout
	 (red)	On	Critical connection failure; device has detected a network error: duplicate MAC-ID or sever error in CAN network (CAN-bus off)
	 (off)	Off	After start of the device and during duplicate MAC-ID check

Table 45: LEDs DeviceNet Master

### 8.3.6 LED DeviceNet Slave

The subsequent table describes the meaning of the LEDs for the fieldbus when the firmware of the DeviceNet Slave protocol is loaded to the device.







LED	Color	State	Meaning
<b>MNS</b> 	<b>Duo LED red/green</b>		
	 (green)	On	Device is online and has one or more connections in the established state
	 (green)	Flashing	Device is online and has no connection in the established state
	 (green/red/off)	Green/Red/Off	Selftest after power on: Green on for 0,25 s, then red on for 0,25 s, then off
	 (red)	On	Critical connection failure; device has detected a network error: duplicate MAC-ID or sever error in CAN network (CAN-bus off)
	 (red)	Flashing	Connection timeout
	 (off)	Off	After start of the device and during duplicate MAC-ID check

Table 46: LEDs DeviceNet Slave

### 8.3.7 LED CC-Link Slave

The subsequent table describes the meaning of the LEDs for the NT 50-CC-xx device when the firmware of the CC-Link Slave protocol is loaded on X2 to the device.





LED	Color	State	Meaning
<b>L RUN</b> <b>L ERR</b> Name in the device drawing:  <b>COM</b>	<b>Duo LED red/green</b>		
	 (off)	Off	1. Before participating in the network 2. Unable to detect carrier 3. Timeout 4. Resetting hardware
	 (green)	On	Receive both refresh and polling signals or just the refresh signal normally, after participating in the network.
	 (red)	Blinking	The switch setting has been changed from the setting at the reset cancellation (blinks for 0.4 sec.).
	 (red)	On	1. CRC error 2. Address parameter error (0, 65 or greater is set including the number of occupied stations) 3. Baud rate switch setting error during cancellation of reset (5 or greater)

Table 47: LEDs CC-Link Slave X2

## 8.4 LEDs Serial Protocols

### 8.4.1 LED Modbus RTU

The subsequent table describes the meaning of the LEDs for the Modbus RTU protocol.



LED	Color	State	Meaning
<b>COM</b> <b>3</b> with protocol at X2  <b>4</b> with protocol at X3	<b>Duo LED red/green</b>		
	 (green)	On	The device has a valid configuration for Modbus RTU and is ready for Modbus communication respectively sends/receives Modbus RTU telegrams
	 (red)	On	Communication error: The device works as <b>Modbus RTU Master</b> : - the slave device answered with a error (Modbus Exception), e. g. functioncode not supported, access to invalid register addresses or coil addresses - receive error detected, e. g. parity error or checksum error - timeout (slave device does not answer) The device works as <b>Modbus RTU Slave</b> : - the Modbus RTU Master device uses an invalid functioncode - the Modbus RTU Master device has accessed an invalid register addresses or coil addresses - receive error detected, e. g. parity error or checksum error - timeout (application does not answer or answers with error) The error display is set back with the next error free Modbus telegram sequence
	 (off)	Off	During initialisation or invalid Modbus RTU configuration or missing power supply

Table 48: LEDs Modbus RTU Protocol

### 8.4.2 LED ASCII

The subsequent table describes the meaning of the LEDs for the ASCII protocol.





LED	Color	State	Meaning
<b>COM</b> <b>3</b> with protocol at X2  <b>4</b> with protocol at X3	<b>Duo LED red/green</b>		
	 (green)	Flashing cyclic with 5 Hz	The device sends/receive data
	 (green)	On	The device is ready for serial communication
	 (red)	Flashing cyclic with 5 Hz	The device is configured and is in the state stop
	 (red)	Flashing cyclic with 1 Hz	The device is not configured
	 (off)	Off	During initialisation or missing power supply

Table 49: LEDs ASCII Protocol

## 9 Technical Data

### 9.1 Technical Data netTAP 50 Gateway

NT 50	Parameter	Value
Communication controller	Type	netX 50
Memory	RAM	8 MB SDRAM
	FLASH	4 MB serial Flash
Diagnostic Interface	Socket	RJ45 Socket 4-pin Ethernet
Display	LED Display	SYS System Status APL Application Status COM Communication Status LINK Link ACT Activity
Power supply	Voltage	24 V ± 6 V DC
	Current at 24 V (typically)	72 mA 150 mA with short circuit at the output of PROFIBUS
		 Continuous short circuit may cause device damage
	Power Consumption	1,8 W
	Connector	Mini-COMBICON, 2-pin
Environmental conditions	Temperature rang	0 ... + 60 °C
	Humidity	no condensation allowed
Device	Dimensions (L x W x H)	100 x 26 x 66 mm (without connector)
	Weight	appr. 80 g
	Mounting	on DIN rail EN 60715
	Protection Class	IP 20
	RoHS	Yes
CE Sign	CE Sign	Yes
	Emission	CISPR 11 Class A
	Immunity	EN 61131-2:2003
Configuration	Software	SYCON.net

Table 50: Technical Data NT 50 (Part 1)

NT 50	Parameter	Value
Ethernet Interface for the device types: NT 50-DP-EN, NT 50-CO-EN, NT 50-DN-EN, NT 50-RS-EN	Transmission rate	100 MBit/s 10 MBit/s (depending on loaded firmware)
	Interface Type	100 BASE-TX, isolated 10 BASE-TX (depending on loaded firmware), isolated
	Half duplex/Full duplex	supported (at 100 MBit/s)
	Auto-Negotiation	supported (depending on loaded firmware)
	Auto-Crossover	supported
	Connector	1 * RJ45
PROFIBUS Interface for the device types NT 50-DP-EN	Transmission rate	9,6 kBit/s, 19,2 kBit/s, 31,25 kBit/s, 45,45 kBit/s, 93,75 kBit/s, 187,5 kBit/s, 500 kBit/s, 1,5 MBit/s, 3 MBit/s, 6 MBit/s, 12 MBit/s
	Interface Type	RS 485, optically isolated
	Connector	SubD female, 9-pin
CANopen Interface for the device type: NT 50-CO-XX	Transmission rate	10 kBit/s, 20 kBit/s, 50 kBit/s, 100 kBit/s, 125 kBit/s, 250 kBit/s, 500 kBit/s, 800 kBit/s, 1 MBit/s
	Interface Type	ISO 11898, optically isolated
	Connector	SubD male, 9-pin
DeviceNet Interface for the device type: NT 50-DN-EN	Transmission rate	125 kBit/s, 250 kBit/s, 500 kBit/s
	Interface Type	ISO 11898, optically isolated
	Connector	COMBICON, 5-pin
Serial Interface for the device type: NT 50-xx-RS	Interface Type	RS-232, RS-422, RS-485
	Connector	RJ45 Ethernet and serial interface together in one connector

Table 51: Technical Data NT 50 (Part 2)

## 9.2 Technical Data of Real-Time Ethernet Communication Protocols

### 9.2.1 EtherNet/IP Scanner (Master) Link

Parameter	Description
Maximum number of EtherNet/IP connections	1 connections for implicit (to one Adapter/Slave only)
Maximum number of cyclic input data	504 bytes
Maximum number of cyclic output data	504 bytes
IO Connection type	Cyclic, minimum 1 ms (depending on the used number of input and output data)
UCMM, Class 3	Supported
Predefined standard objects	Identity Object Message Route Object Assembly Object Connection Manager Ethernet Link Object TCP/IP Object
ACD (Address Conflict Detection)	Supported
DHCP	Supported
BOOTP	Supported
Baud rates	10 and 100 MBit/s
Data transport layer	Ethernet II, IEEE 802.3
Integrated switch	Supported
Limitations	No acyclic user data communication CIP Sync Services are not implemented TAGs are not supported
Reference to firmware/stack version	V2.4.x.x

Table 52: Technical Data EtherNet/IP Scanner (Master) Link Protocol

### 9.2.2 EtherNet/IP Adapter (Slave)

Parameter	Description
Maximum number of input data	504 bytes
Maximum number of output data	504 bytes
IO Connection	1 explicit owner, up to 2 listen only
IO Connection type	Cyclic, minimum 1 ms
UCMM	Supported
Predefined standard objects	Identity Object Message Route Object Assembly Object Connection Manager Ethernet Link Object TCP/IP Object
DHCP	Supported
BOOTP	Supported
Baud rates	10 and 100 MBit/s
Data transport layer	Ethernet II, IEEE 802.3
Integrated switch	Supported
Limitations	No acyclic user data communication CIP Sync Services are not implemented TAGs are not supported ACD (Address Conflict Detection) not supported DLR not supported (ring topology)
Reference to firmware/stack version	V2.1.x.x

Table 53: Technical Data EtherNet/IP Adapter (Slave) Protocol

### 9.2.3 Open Modbus/TCP

Parameter	Description
Maximum number of input data	256 Registers
Maximum number of output data	256 Registers
Acyclic communication	Read/Write Register: - Max. 125 Registers per Read Telegram (FC 3, 4, 23), - Max. 121 Registers per Write Telegram (FC 23), - Max. 123 Registers per Write Telegram (FC 16) Read/Write Coil: - Max. 2000 Coils per Read Telegram (FC 1, 2), - Max. 1968 Coils per Write Telegram (FC 15)
Modbus Function Codes	1, 2, 3, 4, 5, 6, 7, 15, 16, 23 (Function code 23 in server mode only)
Protocol Mode	Client or Server
Baud rates	10 and 100 MBit/s
Data transport layer	Ethernet II, IEEE 802.3
Reference to stack version	V2.5.x.x

Table 54: Technical Data Open Modbus/TCP Protocol



### 9.2.4 PROFINET IO-RT-Controller Link

Parameter	Description
Maximum number of PROFINET IO Devices	1 (to one IO Device only)
Maximum number of cyclic input data	1024 bytes per device (= IOCR data length)
Maximum number of cyclic output data	1024 bytes per device (= IOCR data length)
Supported Protocols	RTC – Real Time Cyclic Protocol, Class 1 RTA – Real Time Acyclic Protocol DCP – Discovery and configuration Protocol CL-RPC – Connectionless Remote Procedure Call
Context management by CL-RPC	Supported
Minimum cycle time	1 ms Different IO-Devices can be configured with different cycle times
Baud rate	100 MBit/s Full-Duplex mode
Data transport layer	Ethernet II, IEEE 802.3
Configuration File	Maximum 1 MByte
Limitations	<p>Read/Write Record not supported</p> <p>No Alarm processing</p> <p>RT over UDP not supported</p> <p>Multicast communication not supported</p> <p>DHCP is not supported</p> <p>Only one IOCR per IO Device</p> <p>NameOfStation of IO Controller CANNOT be set using the DCP SET NameOfStation service but only at start-up while configuring the IO Controller</p> <p>The buffer for IO-Device diagnosis data will be overwritten in case of multiple diagnostic events. Only one (the last) event is stored at the same time. If a single event produces more than 200 bytes of diagnosis data, only the first 200 bytes will be taken care of.</p> <p>The usable (minimum) cycle time depends on the number of used IO Devices, the number of used input and output data. The cycle-time, the number of configured IO Devices and the amount of IO data depend on each other. For example it is not possible due to performance reasons to have 128 IO Devices communication with cycle-time 1ms.</p> <p>The size of the bus configuration file is limited by the size of the RAM Disk (1 MByte)</p> <p>Only one API (API = 0) is supported. Any Profile requesting a different API is currently not supported.</p> <p>WriteMultiple-Record service is not supported</p>
Reference to firmware/stack version	V2.5.x.x

Table 55: Technical Data PROFINET IO RT Controller Link Protocol

### 9.2.5 PROFINET IO-RT-Device

Parameter	Description
Maximum number of cyclic input data	1024 bytes
Maximum number of cyclic output data	1024 bytes
Supported protocols	RTC – Real Time Cyclic Protocol, Class 1 and 2 (unsynchronized) RTA – Real Time Acyclic Protocol DCP – Discovery and configuration Protocol CL-RPC – Connectionless Remote Procedure Call LLDP – Link Layer Discovery Protocol SNMP – Simple Network Management Protocol
Used Protocols (subset)	UDP, IP, ARP, ICMP (Ping)
Topology recognition	LLDP, SNMP V1, MIB2, physical device
VLAN- and priority tagging	yes
Context Management by CL-RPC	Supported
Minimum cycle time	1 ms
Baud rate	100 MBit/s
Data transport layer	Ethernet II, IEEE 802.3
Limitations	No acyclic user data transfer RT over UDP not supported Multicast communication not supported Only one device instance is supported DHCP is not supported RT Class 2 synchronized (IRT 'flex') is not supported RT Class 3 is not supported FastStartUp is not supported Media Redundancy is not supported Access to the submodule granular status bytes (IOPS & IOCS) is not supported The amount of configured IO-data influences the minimum cycle time that can be reached. Supervisor-AR is not supported, Supervisor-DA-AR is supported Only 1 Input-CR and 1 Output-CR are supported Multiple WriteRequests are not supported
Reference to stack version	V3.4.x.x

Table 56: Technical Data PROFINET IO RT Device Protocol

## 9.3 Technical Data Fieldbus Protocols

### 9.3.1 CANopen Master Link

Parameter	Description
Maximum number of CANopen nodes	1 (to one node only)
Maximum number of cyclic input data	512 bytes
Maximum number of cyclic output data	512 bytes
Maximum number of receive PDOs	64
Maximum number of transmit PDOs	64
Exchange of process data	Via PDO transfer: - synchronized, - remotely requested and - event driven (change of date)
Functions	Emergency message (consumer) Node guarding / life guarding, heartbeat PDO mapping NMT Master SYNC protocol (producer) Simple boot-up process, reading object 1000H for identification
Baud rates	10 kBits/s, 20 kBits/s, 50 kBits/s, 100 kBits/s, 125 kBits/s, 250 kBits/s, 500 kBits/s, 800 kBits/s, 1 MBits/s
Data transport layer	CAN Frames
CAN Frame type	11 Bit
Limitations	SDO-Upload/Download for user data transfer not supported
Reference to firmware/stack version	V2.2.x.x

Table 57: Technical Data CANopen Master Link Protocol

### 9.3.2 CANopen Slave

Parameter	Description
Maximum number of cyclic input data	512 bytes Objects 2200, 2201, 2202, 2203 each with up to 128 bytes
Maximum number of cyclic output data	512 bytes Objects 2000, 2001, 2002, 2003 each with up to 128 bytes
Maximum number of receive PDOs	64
Maximum number of transmit PDOs	64
Exchange of process data	Via PDO transfer - synchronized, - remotely requested and - event driven (change of date, event timer)
Functions	Node guarding / life guarding, heartbeat PDO mapping NMT Slave SYNC protocol (consumer) SDO upload/download (server, for configuration) Emergency message (producer)
Baud rates	10 kBits/s, 20 kBits/s, 50 kBits/s, 100 kBits/s, 125 kBits/s, 250 kBits/s, 500 kBits/s, 800 kBits/s, 1 MBits/s Auto baudrate detection is supported
Data transport layer	CAN Frames
CAN Frame type for CANopen	11 Bit
Limitations	Timestamp (producer/consumer) not supported on application level.
Reference to stack version	V3.0.x.x

Table 58: Technical Data CANopen Slave Protocol

#### Configuration of the node address

The CANopen node address can be configured by SYCON.net or by address switches. The address switches can be activated with SYCON.net version 1.351 (or higher) and can be used with firmware version 1.1 (or higher).

### 9.3.3 CC-Link Slave

Parameter	Description
<b>Firmware works according to CC-Link Version 2.0:</b>	
Station Types	Remote Device Station (up to 4 occupied stations)
Maximum input data	368 bytes
Maximum output data	368 bytes
Input data remote device station	112 bytes (RY) and 256 bytes (RWw)
Output data remote device station	112 bytes (RX) and 256 bytes (RWr)
Extension cycles	1, 2, 4, 8
Baud rates	156 kBit/s, 625 kBit/s, 2500 kBit/s, 5 MBit/s, 10 MBit/s
Limitation	Intelligent Device Station not supported
<b>Firmware works according to CC-Link Version 1.11:</b>	
Station Types	Remote I/O station, Remote device station' (up to 4 occupied stations)
Maximum input data	48 bytes
Maximum output data	48 bytes
Input data remote I/O station	4 bytes (RY)
Output data remote I/O station	4 bytes (RX)
Input data remote device station	4 bytes (RY) and 8 bytes (RWw) per occupied station
Output data remote device station	4 bytes (RX) and 8 bytes (RWr) per occupied station
Baud rates	156 kBit/s, 625 kBit/s, 2500 kBit/s, 5 MBit/s, 10 MBit/s
Firmware	
Reference to stack version	V2.6.x.x

Table 59: Technical Data CC-Link-Slave Protocol

#### Configuration of the station number

The CC-Link station number can be configured by SYCON.net or by address switches. The address switches can be activated with SYCON.net version 1.351 (or higher) and can be used with firmware version 1.1 (or higher).

### 9.3.4 DeviceNet Master Link

Parameter	Description
Maximum number of DeviceNet slaves	1 (one slave only)
Maximum number of total cyclic input data	255 bytes
Maximum number of total cyclic output data	255 bytes
Maximum Configuration data	1000 bytes
Connections	Bit Strobe Change of State Cyclic Poll Explicit Peer-to-Peer Messaging (Only for parameterization)
Function	Quick Connect
Fragmentation	Explicit and I/O
UCMM	Supported
Objects	Identity Object (Class Code 0x01) Message Router Object (Class Code 0x02) DeviceNet Object (Class Code 0x03) Connection Object (Class Code 0x05) Acknowledge Handler Object (Class Code 0x06)
Baud rates	125 kBits/s, 250 kBit/s, 500 kBit/s Auto baudrate detection is not supported
Data transport layer	CAN frames
Limitations	User data transfer through the gateway only via IO connections
Reference to firmware/stack version	V2.2.x.x

Table 60: Technical Data DeviceNet Master Link Protocol

### 9.3.5 DeviceNet Slave

Parameter	Description
Maximum number of cyclic input data	255 bytes
Maximum number of cyclic output data	255 bytes
Connections	Poll Change-of-state Cyclic Bit-strobe
Fragmentation	Explicit and I/O
UCMM	Not supported
Baud rates	125 kBits/s, 250 kBit/s, 500 kBit/s Auto baudrate detection is not supported
Data transport layer	CAN frames
Limitations	Access to Application Object only via IO connection
Reference to stack version	V2.3.x.x

Table 61: Technical Data DeviceNet Slave Protocol

#### Configuration of the MAC ID

The DeviceNet MAC ID can be configured by SYCON.net or by address switches. The address switches can be activated with SYCON.net version 1.351 (or higher) and can be used with firmware version 1.1 (or higher).

### 9.3.6 PROFIBUS-DP Master Link

Parameter	Description
Maximum number of PROFIBUS DP slaves	1 (to one slave only)
Maximum number of cyclic input data	244 bytes
Maximum number of cyclic output data	244 bytes
Configuration data	Max. 244 bytes
Parameterization data	7 bytes standard parameters Max. 237 bytes application specific parameters
Baud rate	9,6 kBits/s, 19,2 kBits/s, 31,25 kBits/s, 45,45 kBits/s, 93,75 kBits/s, 187,5 kBits/s, 500 kBits/s, 1, 5 MBits/s, 3 MBits/s, 6 MBits/s, 12 MBit/s Auto baudrate detection is not supported
Data transport layer	PROFIBUS FDL
Limitations	DP V1 services class 1 and 2 are not supported DP V2 services are not implemented
Reference to firmware/stack version	V2.3.x.x

Table 62: Technical Data PROFIBUS DP Master Link Protocol



### 9.3.7 PROFIBUS DP Slave

Parameter	Description
Maximum number of cyclic input data	244 bytes
Maximum number of cyclic output data	244 bytes
Maximum number of modules	Max. 4 input modules and max. 4 output modules, max. 24 modules when using manual setting
Baud rate	9,6 kBits/s, 19,2 kBits/s, 31,25 kBits/s, 45,45 kBits/s 93,75 kBits/s, 187,5 kBits/s, 500 kBits/s, 1, 5 MBits/s, 3 MBits/s, 6 MBits/s, 12 MBit/s Auto baudrate detection is supported
Data transport layer	PROFIBUS FDL
Limitations	DP V1 services class 1 and 2 to transfer user data are not supported SSCY1S – Slave to slave communication state machine not implemented Data exchange broadcast not implemented I&M0 with fixed settings only
Reference to firmware/stack version	V2.4.x.x

Table 63: Technical Data PROFIBUS DP Slave Protocol

#### Configuration of the station address

The PROFIBUS station address can be configured by SYCON.net or by address switches. The address switches can be activated with SYCON.net version 1.351 (or higher) and can be used with firmware version 1.1 (or higher).

## 9.4 Technical Data serial Protocols

### 9.4.1 ASCII

Parameter	Description and Value Range
Maximum telegram length	1024 bytes
Data bits	7, 8 bits
Stop bits	1, 2 bit(s)
Parity	None, even, odd
Baud rate	300 bit/s, 600 bit/s, 1200 bit/s, 2400 bit/s, 4800 bit/s, 9600 bit/s, 19200 bit/s, 38400 bit/s, 57600 bit/s, 115200 bit/s
Duplex	Half-duplex
Flow control	None
Indicator for end of received telegram	On receipt of a fixed number of characters On receipt of termination character(s) Elapse of character delay time
Timing parameter	Response timeout Receive watchdog time Send cycle time Character delay time
Number of send buffers	1
Number of receive buffers	1
Number of transmission retries	1
Maximum number of structure elements of a send telegram	10
Maximum number of structure elements of a receive telegram	10
Structure elements	Start character(s), Device address, Object index or start address, Command identifier, Data area with length information, Data area with termination character(s), End character(s), Checksum, Character(s) without meaning (fix length)
Checksum methods	CRC8, CRC16, CRC32, Exor
Reference to stack version	V1.0.x.x

Table 64: Technical Data ASCII Protocol

### 9.4.2 Modbus RTU Master/Slave

Parameter	Description and Value Range
Maximum number of input data	256 Registers
Maximum number of output data	256 Registers
Acyclic communication	Read/Write Register, Maximum 125 Registers per Read Telegram (FC 3, 4), Maximum 123 Registers per Write Telegram (FC 16), Maximum 118 Registers per Write Telegram (FC 23), Maximum 118 Registers per Read Telegram (FC 23) Read/Write Coil, Maximum 2000 Coils per Read Telegram (FC 1, 2), Maximum 1968 Coils per Write Telegram (FC 15)
Function Codes Modbus Master	1, 2, 3, 4, 5, 6, 15, 16
Function Codes Modbus Slave	1, 2, 3, 4, 5, 6, 7, 8, 15, 16, 23
Mode	Modbus Master or Modbus Slave
Baud rates	1200 bit/s, 2400 bit/s, 4800 bit/s, 9600 bit/s, 19200 bit/s, 38400 bit/s, 57600 bit/s, 115200 bit/s
Data bits	8 bits
Stop bits	1, 2 bit(s)
Parity	None, even, odd
Limitations	Broadcast not supported
Reference to stack version	V1.3.x.x

Table 65: Technical Data Modbus RTU Protocol

## 10 Wiring Instructions

Please note the wiring instructions for the corresponding protocol specifications, otherwise a perfect function of the device is not guaranteed.

Use shielded cables, where the shield at both end should be connect extensively with the potential equalization. Cables for communication should be layed/placed as far away as possible from cables transferring energy, to avoid EMC influence caused by switching operation from cables transferring energy.

## 10.1 Assembly of D-Sub Connectors

The design of the bus cabling is an essential factor for the proper function of communication. Therefore, special attention should be paid to the cable connections with its connectors. Particularly, ensure good shield connection.

The shield must be connected as follows

1. Dismantle the cable.
2. Pull back the shielding from the cable sheathing.
3. Reduce the shielding that later it is covered by the nozzle.
4. Push a nozzle or shrinking tube over the cable sheathing that at the cable end a zone of 5 to 8 mm remains free.
5. Connect the wire ends with the connector
6. Then push the cable in the plug to the bare braided shield under the strain relief.
7. Fix the strain relief with screws.

The cable connection should look like shown below:

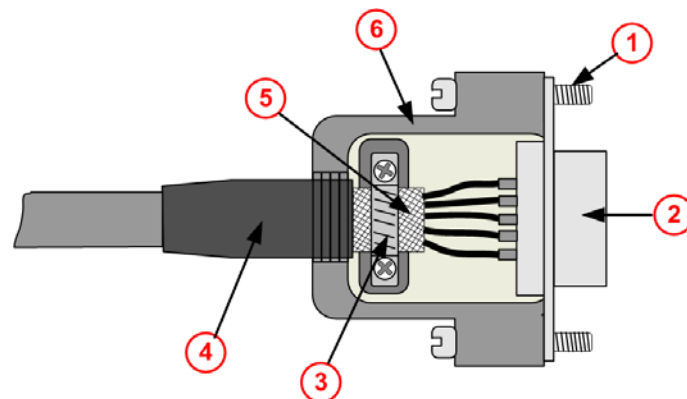

Figure 11: D-Sub Cable Assemblies

- ① Fixing screw UNC.
- ② Metallic plug collar
- ③ Strain relief for connecting the shielding with the connector housing
- ④ Shrinking tube or nozzle to cover the shielding and for bend protection
- ⑤ Cable shielding pulled back over the cable sheathing
- ⑥ Metallic or metallized connector housing

## 10.2 Ethernet

### Use of Hubs and Switches

For the corresponding communication systems, the use of hubs and/or switches is either forbidden or allowed. The following table shows the acceptable use of hubs and switches by each communication system:

Communication System	Hub	Switch
<b>EtherCAT</b>	forbidden	only allowed between EtherCAT Master and first EtherCAT Slave (100 MBit/s, Full Duplex)
<b>EtherNet/IP</b>	allowed	allowed (10 MBit/s/100 MBit/s, Full or Half Duplex, Auto-Negotiation)
<b>Open Modbus/TCP</b>	allowed	allowed (10 MBit/s/100 MBit/s, Full or Half Duplex, Auto-Negotiation)
<b>POWELINK</b>	allowed	forbidden
<b>PROFINET IO RT</b>	forbidden	Only allowed, if the switch supports 'Priority Tagging' and LLDP (100 MBit/s, Full Duplex)
<b>SERCOS III</b>	forbidden	forbidden

Table 66: Use of Hubs and Switches

When using older NT 50-xx-EN respectively NT 50 xx-RS devices, then follow:



#### NOTICE

#### Failure of the Network Communication

- Do not operate hardware with the communication controllers netX 50, netX100 or netX 500 with the protocols Ethernet TCP/UDP/IP, EtherNet/IP or Modbus TCP at 10 MBit/s in half-duplex mode, otherwise failure of the network communication can occur.
- Use only switches or 10/100 MBit/s dual-speed hubs and ensure that the network operates at 100 MBit/s and in full-duplex mode.

For further information refer to section *Failure in 10 MBit/s Half Duplex Mode and Workaround* on page 39.

## 10.3 PROFIBUS

Please ensure that termination resistors are available at both ends of the cable. If special PROFIBUS connectors are being used, these resistors are often found inside the connector and must be switched on. For baud rates above 1.5 Mbaud use only special connectors, which also include additional inductance.

It is not permitted to have T-stubs on PROFIBUS high baud rates. Use only a special cable which is approved for PROFIBUS-DP. Make a solid connection from the cable shield to ground at every device and make sure that there is no potential difference between the grounds at the devices.

If the Hilscher device is linked with only one other device on the bus, they must be at the ends of the bus line. The reason is that these devices must deliver the power supply for the termination resistors. Otherwise the Master can be connected at any desired position.

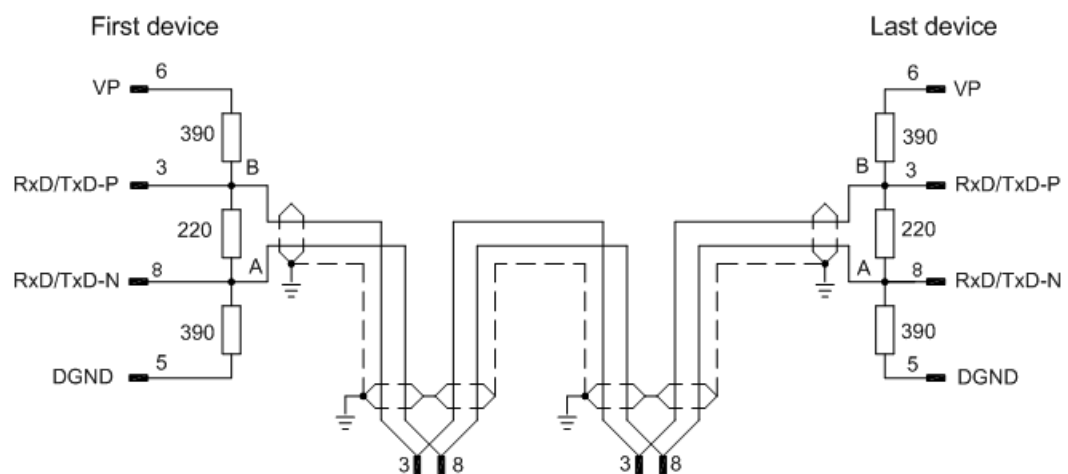

Figure 12: PROFIBUS-DP-Network

Up to 32 PROFIBUS devices can be connected to one bus segment. If several bus segments are linked to each other with repeaters, there can be up to 127 devices on the network.

Only PROFIBUS certified cable, preferably the cable type A, should be used.

The maximum length of a bus segment depends on the baudrate used, see the following table.

Baud rate in kBit/s	Max. distance in m
9,6	1.200
19,2	1.200
93,75	1.200
187,5	1.000
500	400
1.500	200
3.000	100
6.000	100
12.000	100

Table 67: PROFIBUS Segment Length in Dependence of the Baud Rate

The following table contains the most important electrical data concerning PROFIBUS certified cable:

Parameter	Value
Impedance	135...165 $\Omega$
Capacity	< 30 pF/m
Loop resistance	110 $\Omega$ /km
Wire gauge	0,64 mm

Table 68: Characteristics of PROFIBUS certified Cable



## 10.4 CANopen

Please use only CAN certified cable with the following characteristics:

Parameter	Value
Impedance	120 Ω ± 12 Ω
Capacity	< 50 pF/m

Table 69: Characteristics of CAN certified Cable

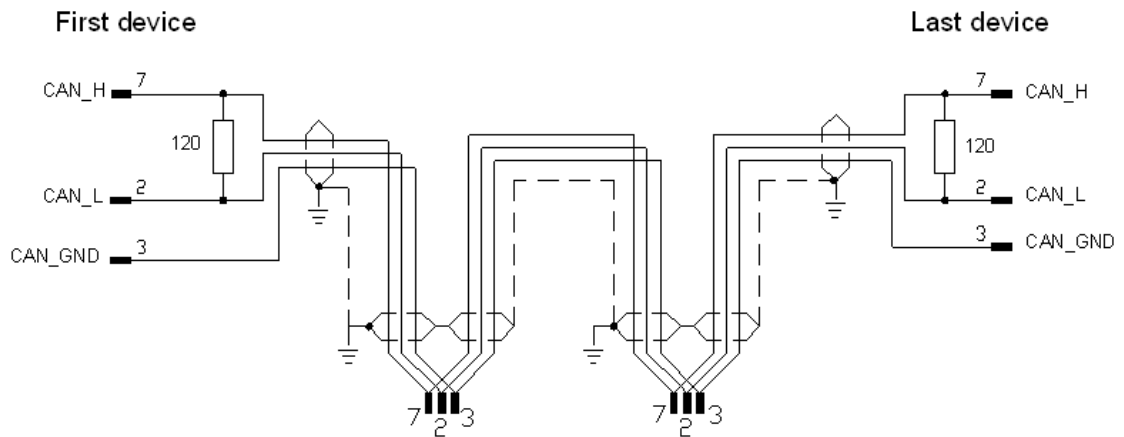

Figure 13: Termination CANopen Network

The pin numbers in the figure above refer to M12 connectors. If you use devices in the network with other types of connectors, take care that the pin numbers of those devices can be different from the figure above.

At the ends of the network there must be two resistors of 120 Ω to terminate the cable. It is allowed to use repeaters to increase the number of nodes, which may be connected, or to increase the maximum cable length.

The CAN segment length in dependence of the Baud rate or corresponding Loop Resistance and Wire Gauge is given in the following table:

Baud rate in kBit/s	Max. distance	Loop Resistance	Wire Gauge
10	1000 m	<26 Ω/km	0,75...0,80 mm <sup>2</sup>
20	1000 m	<26 Ω/km	0,75...0,80 mm <sup>2</sup>
50	1000 m	<26 Ω/km	0,75...0,80 mm <sup>2</sup>
125	500 m	<40 Ω/km	0,50...0,60 mm <sup>2</sup>
250	250 m	<40 Ω/km	0,50...0,60 mm <sup>2</sup>
500	100 m	<60 Ω/km	0,34...0,60 mm <sup>2</sup>
800	50 m	<60 Ω/km	0,34...0,60 mm <sup>2</sup>
1.000	40 m	70 Ω/km	0,25...0,34 mm <sup>2</sup>

Table 70: CAN Segment Length in dependence of the Baud rate or corresponding Loop Resistance and Wire Gauge

## 10.5 DeviceNet

Up to 64 DeviceNet devices can be linked together over the bus. The maximum length of the bus cable depends on the used baud rate and the used cable type. Only special proved DeviceNet cable should be used.

The maximum length of the DeviceNet cable depends from the baud rate and from the chosen cable type. In the following table, these are listed in the following table:

Baudrate in kbit/s	Maximum length of cable (thick cable)	Maximum length of cable (thin cable)
125	500 m	100 m
250	250 m	100 m
500	100 m	100 m

Table 71: Maximum length in dependence from the Baud Rate for DeviceNet Cables

The data line cables must match the following conditions:

Data line cable	Impedance	Capacity	Loop Resistance	Wire Gauge (Diameter)
Thick	120 Ohm	<39,4 pf/m	<22,6 Ohm/km	2 * 1.1 mm
Thin	120 Ohm	<39,4 pf/m	<91,8 Ohm/km	2 * 0,6 mm

Table 72 Characteristics of DeviceNet Data Line Cable

The power supply cables must match the following conditions:

Power supply cable	Loop Resistance	Wire Gauge (Diameter)
Thick	<11,8 Ohm/km	2 * 1.4 mm
Thin	<57,4 Ohm/km	2 * 0,7 mm

Table 73: Characteristics of DeviceNet Power Supply Cable

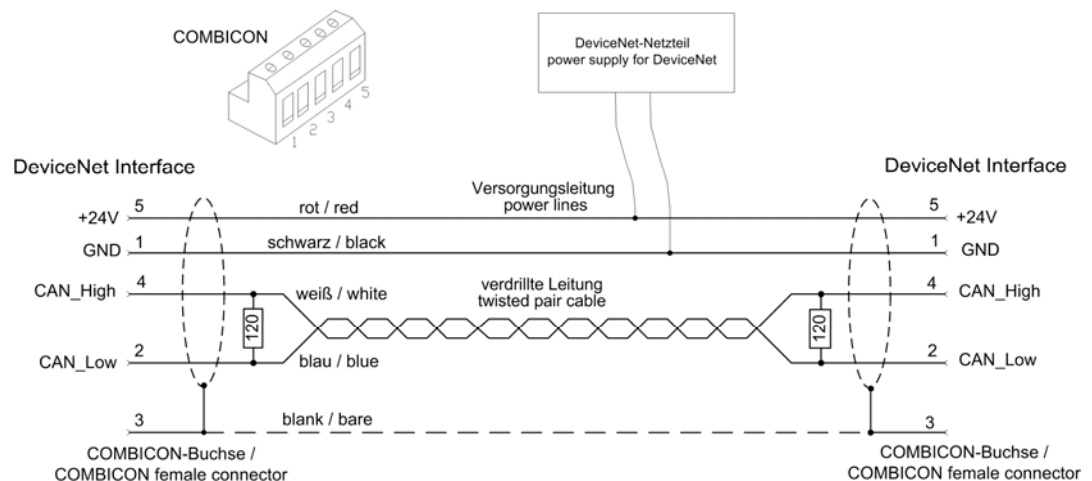

Figure 14: DeviceNet Network

Please ensure that termination resistors with 120 Ohm are available at both ends of the cable.

Further devices can be connected via T-stubs to the bus cable. The maximum length of all T-stubs is 6 m. The whole length of the bus cable and all

T-stubs does not exceed the maximum length listed in the following table. There are two different types of cables. If both cables types are used within the same network, the maximum length is:

Max. distance	Baud rate in kBits/s
$L_{\text{thick}} + 5 \times L_{\text{thin}} \leq 500 \text{ m}$	at 125 kBaud
$L_{\text{thick}} + 2,5 \times L_{\text{thin}} \leq 250 \text{ m}$	at 250 kBaud
$L_{\text{thick}} + L_{\text{thin}} \leq 100 \text{ m}$	at 500 kBaud

*Table 74: DeviceNet Segment Length in dependence of the Baud rate*

The DeviceNet cable contains the data line cables and the power supply cables.

## 10.6 CC-Link

Use only a special cable which is approved for CC-Link. CC-Link specifies several shielded three-core Twisted Pair cables. It is recommended to use only one type of cable for an installation. Please ensure that termination resistors are available at both ends of the cable. The value of the termination resistor depends on the used type of cable and can be 100, 110 and 130  $\Omega$ , respectively.

The following illustration displays the basic network structure.

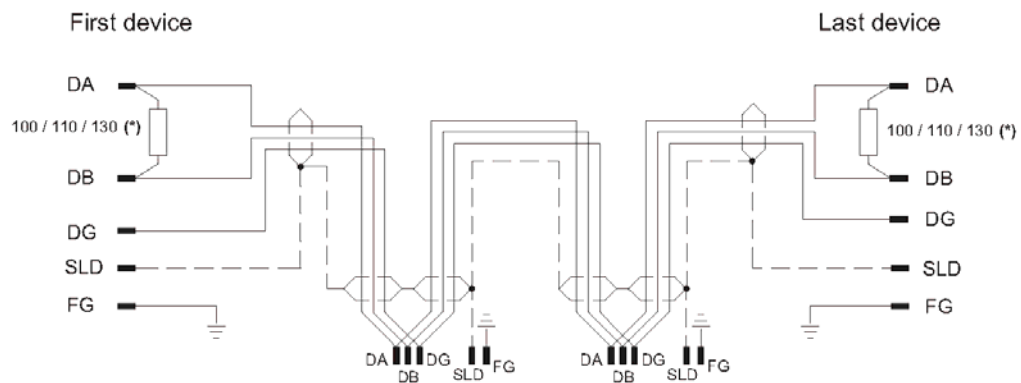

(\*) Termination resistor depends on the used cable type (see CC-Link Cable Wiring Manual).

Figure 15: CC-Link Network

(\*) The termination resistor depends on the used cable type (see CC-Link Cable Wiring Manual).

The maximum length of one bus segment depends on the used baud rate. The structure of the network can be built up without or with branches. The details listed here are taken from the "CC link Cable Wiring manual" from July 2004. Also further details are contained there. The document is ready for download on <http://www.cc-link.org>.



**Note:** For CC-Link V2.00 the cable specification V1.10 has not been changed.

**Only trunk line, without branches:**

Baud rate	max. Length cable V1.00	max. Length cable V1.10 and cable V1.00 with high capacity	max. length high flexible V1.10 (Type 50%)
156 kbps	1200 m	1200 m	600 m
625 kbps	600 m	900 m	450 m
2,5 Mbps	200 m	400 m	200 m
5 Mbps	150 m	160 m	80 m
10 Mbps	100 m	100 m	50 m

Table 75: Maximum length



**Note:** Further cable types are available with which however only lower maximum lengths can be reached.

**Trunk line with branch lines:**

baud rate	156 kbps	625 kbps
max. length trunk line	500 m	100 m
max. number of devices in branch line	6	6
max. cable length of branch line	8 m	8 m
max. length of all branch lines	200 m	50 m

Table 76: Maximum length

Further devices can be connected via T-branches to the bus cable only at the baud rates 156 kbps and 625 kbps. The maximum length of all T-stubs is limited to 8 m. The whole length of the bus cable and all T-branches does not exceed the maximum length listed in the following table.

**Minimum Distance:**

Between two devices a minimum distance is to be kept.

Distance between CC-Link devices	CC-Link cable V1.00	CC-Link cable V1.10
Remote device to next remote device	0.3 m or more	0.2 m or more
Remote device to next Master and/or intelligent device	1 m or more	0.2 m or more

Table 77: Minimum distance between two devices

## 10.7 RS-232



### NOTICE

#### Device Damage!

- Make sure that the NT 50 device and the remote device via RS-232 have the same potential or insert a galvanic isolation, to avoid compensation current between the used devices.

The RS232 interface (EIA-232) is a point-to-point connection of two communication devices. Only shielded cables have to be used. No termination resistors are required.

Take care of the pin assignment at the communication partner. This decides, whether you need a so called null modem cable with crossed pin assignments.

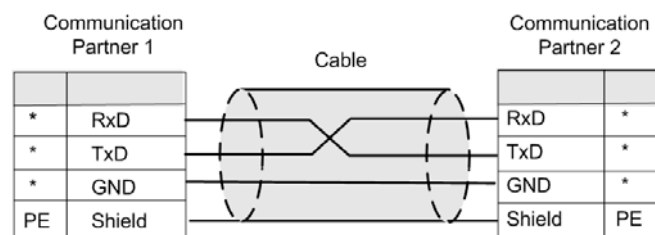

Figure 16: RS-232 Null-Modem Cable Connection

- \* Pinning of the remote device: see device description of the used device.

#### Conductor length and transmission rates

In the EIA-232 norm a maximum cable capacitance of 2500 pF is allowed for a RS232 connection.

Cables of such capacitance may have the following lengths depending on the baud rate

max. baud rate	max. length
19.200	15 m
57.600	5 m
115.200	<2 m

Higher length can be achieved with cables of extraordinarily low capacitance.

## 10.8 RS-422



### NOTICE

#### Device Damage!

- Make sure that the NT 50 device and the remote device via RS-422 have the same potential or insert a galvanic isolation, to avoid compensation current between the used devices.

The lines of this industry bus interface are operated in push-pull action, four lines are required which can be controlled in half duplex or full duplex mode. This interface has been designed for one master and at maximum 10 slaves. Using repeaters, using even more slaves is possible.

Cable lengths of up to 1.2 km (at low baud rates) and data transmission rates of up to 10 MBit/s (at maximally 12 m length of line) are possible. The maximum useable transmission rate depends on the technical data of the used devices.

The following illustration shows wiring for RS-422:

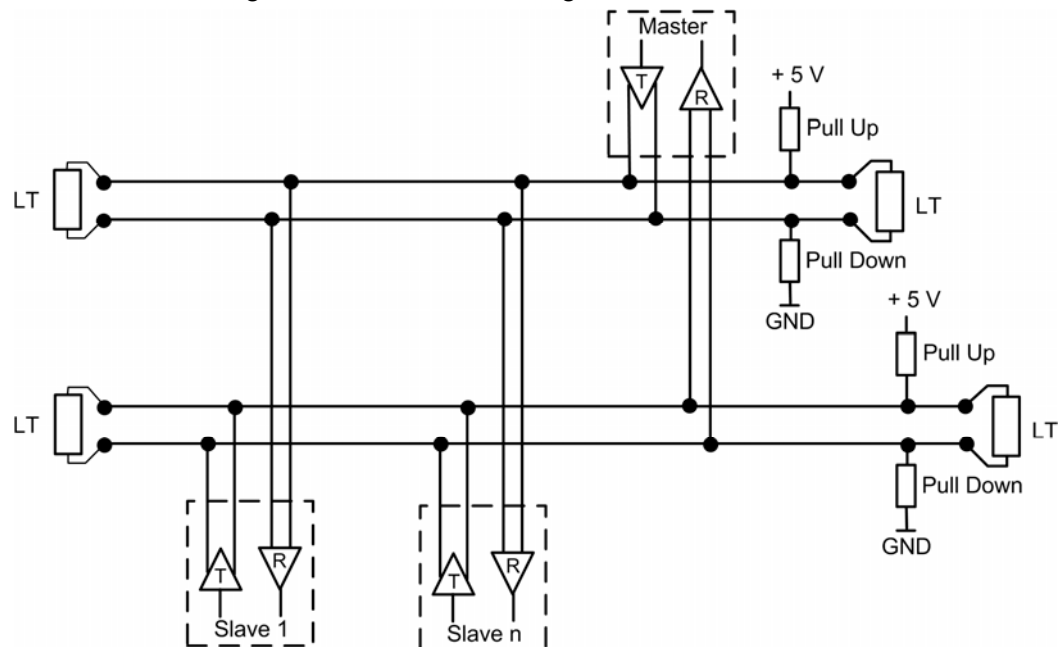

Figure 17: RS-422 Wiring

#### **Bus Requirements:**

The bus cable must be a shielded 4-wire twisted pair cable. Each pair of wires has to be used for exactly one data transmission direction. The shield should be connected at both ends to the potential equalization system.

On each end, the bus requires a termination resistor (LT) of 90  $\Omega$  to 150  $\Omega$  between the lines. This value depends on the characteristic wave impedance of the cable.

The pull-up and pull-down resistors should have a resistance of 390  $\Omega$  up to 650  $\Omega$ .

**Cable Requirements:**

The workmanship of bus cabling is an important factor of the reliable operation and also for the electromagnetic compatibility and emission. It is mandatory to use shielded twisted-pair cables. The shield of the cable must consist of a copper wire mesh.

Parameter	Value
Characteristic wave impedance	150 $\Omega \pm 15 \Omega$
Capacitance	< 30 pF/m
Loop resistance	110 $\Omega$ /km
Wire gauge	0,64 mm

Table 78: Electric Requirements to RS-422 Cables

The following lengths of lines can be achieved:

Max. overall length of line	Max. Baud rate	Max. length of a single branch line
120 m	1 MBit/s	0,3 m
600 m	500 kBit/s	0,6 m
1200 m	100 kBit/s	1,5 m

Table 79: RS-422 Conductor Length and Transmission Rates



## 10.9 RS-485



**NOTICE**

**Device Damage!**

- Make sure that the NT 50 device and the remote device via RS-485 have the same potential or insert a galvanic isolation, to avoid compensation current between the used devices.

The lines of this industry bus interface are operated in push-pull action, only two lines are required which can be controlled in half duplex or full duplex mode. The advantage of the 2-wire technology mainly consists in the multi-master capability. In principle, each participant is able to exchange data with any other participant. However, synchronous send attempts of two or more participants must be prevented by the applied protocol. The RS-485 interface allows the connection of up to 32 transmitters and receivers using a protocol. (With repeaters even more participants are possible.)

Nowadays, RS-485 supports cable lengths of up to 1.2 km (see *Table 81: RS-485 Cable Lengths* on page 82) and data transmission rates of up to 1 MBit/s. The maximum useable transmission rate depends on the technical data of the used devices.

The following illustration shows wiring for RS-485:

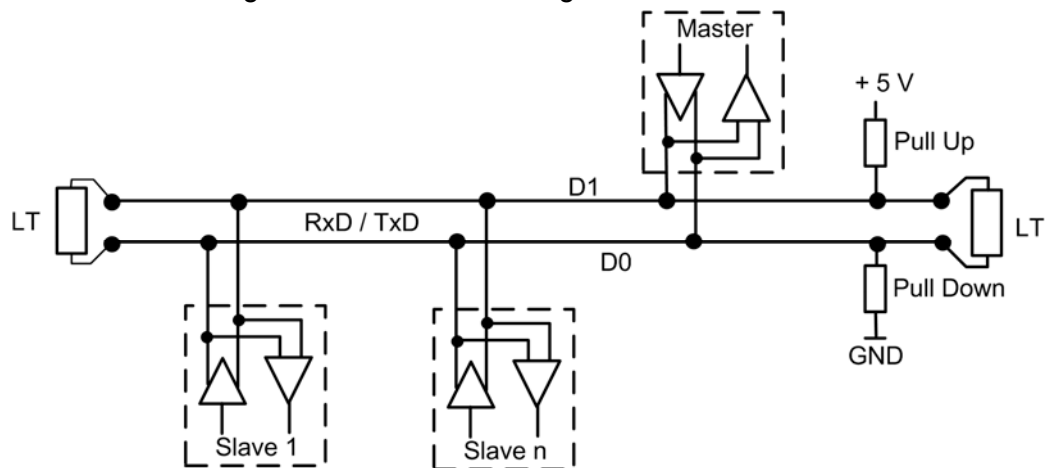

Figure 18: RS-485 Wiring

**Bus requirements:**

The bus cable must be a shielded twisted pair cable where the shield should be connected at both ends with large contact areas to the potential equalization system.

On each end, the bus requires a termination resistor (LT) between the lines D1 und D0 of approximately the amount of the characteristic wave impedance of the cable, which usually amounts to a value between 120  $\Omega$  and 220  $\Omega$ .

The pull-up and pull-down resistors should have a value of 390  $\Omega$  up to 650  $\Omega$ .

**Cable requirements:**

The workmanship of bus cabling is an important factor of the reliable operation and also for the electromagnetic compatibility and emission. It is mandatory to use shielded twisted-pair cables. The shield of the cable must consist of a copper wire mesh.

Parameter	Value
Characteristic wave impedance	150 $\Omega \pm 15 \Omega$
Capacitance	< 30 pF/m
Loop resistance	110 $\Omega$ /km
Wire gauge	0,64 mm

Table 80: Electric Requirements to RS-485 Cables

The following lengths of lines can be achieved:

Max. overall length of line	Max. Baud rate	Max. length of a single branch line
120 m	1 MBit/s	0,3 m
600 m	500 kBit/s	0,6 m
1200 m	100 kBit/s	1,5 m

Table 81: RS-485 Cable Lengths

# 11 Decommissioning/Disposal

## 11.1 Put the Device out of Operation

---

**NOTICE****Danger of unsafe System Operation!**

➤ To prevent property damage, do not remove this device under runtime conditions before you can not guarantee further a safe and secure operation of the plant.

---

- Disconnect the communication cables from the device.
- Disconnect the plug for power supply.
- Remove the device as described in section *Removing the NT 50 from the DIN Top Hat Rail* on page 35.

## 11.2 Disposal of Waste Electronic Equipment

Important note from the European Directive 2002/96/EG Waste Electrical and Electronic Equipment (WEEE):



---

**Waste Electronic Equipment**

- This product must not be treated as household waste.
  - You must dispose the device at a designated waste electronic equipment collecting point.
- 

Waste electronic equipment may not be disposed of with household waste. As a consumer you are legally obliged to dispose all Waste electronic equipment professionally, as to the public collection.

## 12 Appendix

### 12.1 List of Figures

Figure 1: Function NT 50	19
Figure 2: Device Drawings	23
Figure 3: LEDs and Control Elements	24
Figure 4: Range of Values for the Address Switches	24
Figure 5: Galvanic Isolation of NT 50-xx-EN Devices	32
Figure 6: Galvanic Isolation of NT 50-xx-RS Devices	33
Figure 7: Galvanic Isolation of NT 50 -RS-EN Devices	34
Figure 8: Mounting the netTAP NT 50 device onto the top-hat rail	35
Figure 9: Removing the NT 50 device from the Top-Hat Rail	35
Figure 10: LEDs	40
Figure 11: D-Sub Cable Assemblies	69
Figure 12: PROFIBUS-DP-Network	71
Figure 13: Termination CANopen Network	73
Figure 14: DeviceNet Network	74
Figure 15: CC-Link Network	76
Figure 16: RS-232 Null-Modem Cable Connection	78
Figure 17: RS-422 Wiring	79
Figure 18: RS-485 Wiring	81

### 12.2 List of Tables

Table 1: List of Revisions	6
Table 2: Reference to Hardware	8
Table 3: Reference to Software	8
Table 4: Directory Structure of the gateway solution DVD	9
Table 5: Device Description Files for netTAP NT 50 on the DVD	10
Table 6: Basic Documentation for netTAP NT 50	11
Table 7: Additional Documentation for netTAP NT 50 with EtherNet/IP Scanner/Master Link	11
Table 8: Additional Documentation for netTAP NT 50 with PROFINET IO Controller Link	12
Table 9: Additional Documentation for netTAP NT 50 with CANopen Master Link	12
Table 10: Additional Documentation for netTAP NT 50 with DeviceNet Master Link	12
Table 11: Additional Documentation for netTAP NT 50 with PROFIBUS DP Master Link	12
Table 12: Additional Documentation for netTAP NT 50 with ASCII	12
Table 13: Safety Symbols and Sort of Warning or Principle	18
Table 14: Signal Words	18
Table 15: Network on port X2 (Primary Network)	20
Table 16: Network on port X3 (Secondary Network)	20
Table 17: List of Protocol Conversion and NT 50 Device Type	21
Table 18: Supply Voltage Pin Assignment	25
Table 19: CANopen Pin Assignment	25
Table 20: CC-Link Pin Assignment	25
Table 21: DeviceNet Pin Assignment	26
Table 22: PROFIBUS RS-485 Pin Assignment	26
Table 23: RS-232 Pin Assignment	27
Table 24: RS-422 Pin Assignment	27
Table 25: RS-485 Pin Assignment	27
Table 26: Ethernet RJ45 Pin Assignment	28
Table 27: RJ45 Ethernet / RS-232 Pin Assignment	29
Table 28: RJ45 Ethernet / RS-422 Pin Assignment	30
Table 29: RJ45 Ethernet / RS-485 Pin Assignment	31
Table 30: Coupling NT 50-xx-EN Devices	32
Table 31: Coupling NT 50-xx-RS Devices	33
Table 32: Coupling NT 50-RS-EN Devices	34

Table 33: NT 50 Troubleshooting	38
Table 34: LEDs EtherNet/IP Scanner (Master)	41
Table 35: LEDs EtherNet/IP Adapter (Slave)	42
Table 36: LEDs Open Modbus/TCP	43
Table 37: LEDs PROFINET IO-RT Controller	44
Table 38: LEDs PROFINET IO-RT-Device	45
Table 39: LEDs PROFIBUS DP Master – 1 Communication LED	46
Table 40: LEDs PROFIBUS DP Slave	46
Table 41: LEDs CANopen Master	47
Table 42: LED State Definition for CANopen Master for the CAN LED	47
Table 43: LEDs CANopen Slave	48
Table 44: LED State Definition for CANopen Slave for the CAN LED	48
Table 45: LEDs DeviceNet Master	49
Table 46: LEDs DeviceNet Slave	49
Table 47: LEDs CC-Link Slave X2	50
Table 48: LEDs Modbus RTU Protocol	51
Table 49: LEDs ASCII Protocol	51
Table 50: Technical Data NT 50 (Part 1)	52
Table 51: Technical Data NT 50 (Part 2)	53
Table 52: Technical Data EtherNet/IP Scanner (Master) Link Protocol	54
Table 53: Technical Data EtherNet/IP Adapter (Slave) Protocol	55
Table 54: Technical Data Open Modbus/TCP Protocol	56
Table 55: Technical Data PROFINET IO RT Controller Link Protocol	57
Table 56: Technical Data PROFINET IO RT Device Protocol	58
Table 57: Technical Data CANopen Master Link Protocol	59
Table 58: Technical Data CANopen Slave Protocol	60
Table 59: Technical Data CC-Link-Slave Protocol	61
Table 60: Technical Data DeviceNet Master Link Protocol	62
Table 61: Technical Data DeviceNet Slave Protocol	63
Table 62: Technical Data PROFIBUS DP Master Link Protocol	64
Table 63: Technical Data PROFIBUS DP Slave Protocol	65
Table 64: Technical Data ASCII Protocol	66
Table 65: Technical Data Modbus RTU Protocol	67
Table 66: Use of Hubs and Switches	70
Table 67: PROFIBUS Segment Length in Dependence of the Baud Rate	72
Table 68: Characteristics of PROFIBUS certified Cable	72
Table 69: Characteristics of CAN certified Cable	73
Table 70: CAN Segment Length in dependence of the Baud rate or corresponding Loop Resistance and Wire Gauge	73
Table 71: Maximum length in dependence from the Baud Rate for DeviceNet Cables	74
Table 72 Characteristics of DeviceNet Data Line Cable	74
Table 73: Characteristics of DeviceNet Power Supply Cable	74
Table 74: DeviceNet Segment Length in dependence of the Baud rate	75
Table 75: Maximum length	77
Table 76: Maximum length	77
Table 77: Minimum distance between two devices	77
Table 78: Electric Requirements to RS-422 Cables	80
Table 79: RS-422 Conductor Length and Transmission Rates	80
Table 80: Electric Requirements to RS-485 Cables	82
Table 81: RS-485 Cable Lengths	82

## 12.3 Contacts

### Headquarters

#### Germany

Hilscher Gesellschaft für  
Systemautomation mbH  
Rheinstrasse 15  
65795 Hattersheim  
Phone: +49 (0) 6190 9907-0  
Fax: +49 (0) 6190 9907-50  
E-Mail: [info@hilscher.com](mailto:info@hilscher.com)

#### Support

Phone: +49 (0) 6190 9907-99  
E-Mail: [de.support@hilscher.com](mailto:de.support@hilscher.com)

### Subsidiaries

#### China

Hilscher Systemautomation (Shanghai) Co. Ltd.  
200010 Shanghai  
Phone: +86 (0) 21-6355-5161  
E-Mail: [info@hilscher.cn](mailto:info@hilscher.cn)

#### Support

Phone: +86 (0) 21-6355-5161  
E-Mail: [cn.support@hilscher.com](mailto:cn.support@hilscher.com)

#### France

Hilscher France S.a.r.l.  
69500 Bron  
Phone: +33 (0) 4 72 37 98 40  
E-Mail: [info@hilscher.fr](mailto:info@hilscher.fr)

#### Support

Phone: +33 (0) 4 72 37 98 40  
E-Mail: [fr.support@hilscher.com](mailto:fr.support@hilscher.com)

#### India

Hilscher India Pvt. Ltd.  
New Delhi - 110 065  
Phone: +91 11 43055431  
E-Mail: [info@hilscher.in](mailto:info@hilscher.in)

#### Italy

Hilscher Italia S.r.l.  
20090 Vimodrone (MI)  
Phone: +39 02 25007068  
E-Mail: [info@hilscher.it](mailto:info@hilscher.it)

#### Support

Phone: +39 02 25007068  
E-Mail: [it.support@hilscher.com](mailto:it.support@hilscher.com)

#### Japan

Hilscher Japan KK  
Tokyo, 160-0022  
Phone: +81 (0) 3-5362-0521  
E-Mail: [info@hilscher.jp](mailto:info@hilscher.jp)

#### Support

Phone: +81 (0) 3-5362-0521  
E-Mail: [jp.support@hilscher.com](mailto:jp.support@hilscher.com)

#### Korea

Hilscher Korea Inc.  
Suwon, Gyeonggi, 443-734  
Phone: +82 (0) 31-695-5515  
E-Mail: [info@hilscher.kr](mailto:info@hilscher.kr)

#### Switzerland

Hilscher Swiss GmbH  
4500 Solothurn  
Phone: +41 (0) 32 623 6633  
E-Mail: [info@hilscher.ch](mailto:info@hilscher.ch)

#### Support

Phone: +49 (0) 6190 9907-99  
E-Mail: [ch.support@hilscher.com](mailto:ch.support@hilscher.com)

#### USA

Hilscher North America, Inc.  
Lisle, IL 60532  
Phone: +1 630-505-5301  
E-Mail: [info@hilscher.us](mailto:info@hilscher.us)

#### Support

Phone: +1 630-505-5301  
E-Mail: [us.support@hilscher.com](mailto:us.support@hilscher.com)